

Wireless File Transmitter

WFT-E2 II

Instruction Manual for Use With EOS-1D Mark IV

To EOS-1D Mark III or EOS-1Ds Mark III Users

This instruction manual describes the use of the transmitter when connected to the EOS-1D Mark IV. When using the transmitter with the EOS-1D Mark III or EOS-1Ds Mark III, refer to the PDF manual in the EOS_1DIII_1DsIII folder.

To comply with local radio wave regulations, Canon offers four region-specific versions of the transmitter (WFT-E2 IIA, E2 IIB, E2 IIC, and E2 IID) in various areas around the world (p.8). For convenience, we refer to the product in this manual simply as “the transmitter,” without reference to versions A, B, C, or D.

Introduction

The Wireless File Transmitter WFT-E2 II is an accessory for EOS-1D Mark IV camera. It gives the camera wireless and wired LAN functionality and adds a USB port, enabling the following operations.

Wireless and Wired LAN Functions

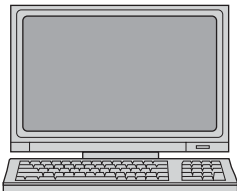

FTP Transfer

Transfer images to an FTP server

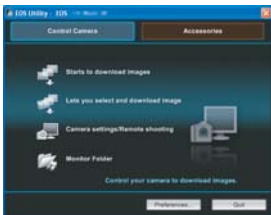

EOS Utility

Use EOS Utility to capture, view, and download images remotely



WFT Server

Use a web browser to capture, view, and download images remotely

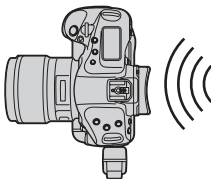

Linked Shooting

Wirelessly trigger shooting by slave cameras linked to a master camera

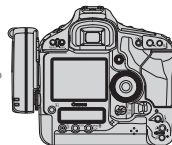

Functions When Connected via USB

External Media

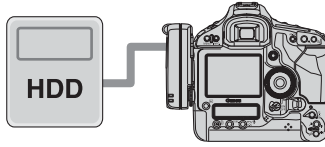

Record or backup images onto external media

GPS

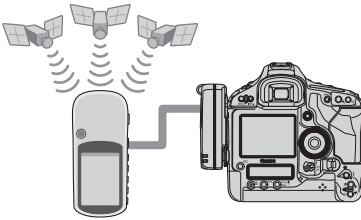

Connected by a USB cable

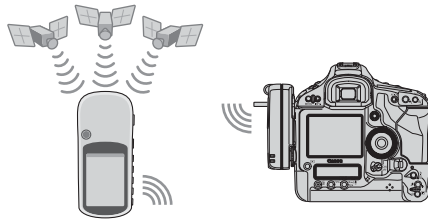

Connected via Bluetooth

Add the latitude, longitude, altitude, date and time, and other shooting information to images

Conventions Used in this Manual

- These instructions should be followed only after your wireless or wired LAN and FTP server settings are complete. For details on configuring these settings, refer to the documentation provided with the respective equipment.
- Terms in brackets [] indicate button or icon names or other software elements. Brackets also denote camera menu items.
- Page numbers in parentheses indicate where you can find additional information.
- Instructions on camera operations should be followed only after you have read the Camera Instruction Manual and are familiar with operating the camera.
- Sections of this manual labeled with the following symbols contain information of the corresponding nature.



: Warnings to avoid potential problems are labeled with a caution symbol.



: Supplemental information is labeled with a note symbol.

- Windows is a trademark or registered trademark of Microsoft Corporation in the United States and other countries.
- Macintosh is a registered trademark of Apple Corporation in the United States and other countries.
- Wi-Fi is a registered trademark of the Wi-Fi Alliance.
- Wi-Fi Certified, WPA, WPA2, and the Wi-Fi Certified logo are trademarks of the Wi-Fi Alliance.
- WPS as used on camera settings screens and in this manual signifies Wi-Fi Protected Setup.
- UPnP is a trademark of the UPnP Implementers Corporation.
- Bluetooth and the Bluetooth logos are trademarks owned by Bluetooth SIG, Inc.
- All other corporate and brand names in this manual are trademarks or registered trademarks of their respective owners.

Using the transmitter for remote image transfer, capture, or viewing requires adequate knowledge of configuring your wireless or wired LAN and FTP server.

Canon cannot provide support for configuring wireless or wired LANs or FTP servers.

Note that Canon cannot be held liable for any loss or damage to the transmitter from erroneous network or FTP server settings. In addition, Canon cannot be held liable for any other loss or damage caused by use of the transmitter.

Chapter List

	Introduction	2
1	Basic Network Settings	15
2	Transferring Images to an FTP Server	29
3	Remote Capture Using EOS Utility	43
4	Remote Capture Using WFT Server	49
5	Linked Shooting	61
6	Managing Settings Information	65
7	Using External Media	71
8	Using GPS Devices	83
9	Troubleshooting	91
10	Reference	109

Contents

Introduction	2
Conventions Used in this Manual	4
Chapter List.....	5
Contents.....	6
Areas of Use and Restrictions	8
Safety Warnings.....	10
Nomenclature.....	11
Attaching to the Camera	12
Subsequent Organization of This Manual.....	13
1 Basic Network Settings	15
Getting Ready	16
Displaying the Connection Wizard	17
Selecting the Communication Method and LAN Type	18
Using the Wizard to Establish a Connection	21
WPS Connections (PBC Mode)	23
WPS Connections (PIN Mode)	24
Configuring Network Settings	25
2 Transferring Images to an FTP Server	29
Configuring FTP Communication Settings.....	30
Automatic Image Transfer After Each Shot	32
Transferring Images Individually	34
Batch Transfer	36
Checking Image Transfer History	40
Viewing Transferred Images.....	41
3 Remote Capture Using EOS Utility	43
Configuring EOS Utility Communication Settings	44
Using EOS Utility	47
4 Remote Capture Using WFT Server	49
Configuring WFT Server Communication Settings	50
Displaying WFT Server	52
Viewing Images.....	53
Remote Capture [Camera control]	55
Remote Capture [Simple control].....	58
Remote Capture.....	59
5 Linked Shooting	61
Setting Up Linked Shooting	62
Arranging the Slave Cameras.....	64

6	Managing Settings Information	65
	Checking Settings	66
	Changing Settings.....	67
	Saving and Loading Settings	69
7	Using External Media	71
	Connecting External Media	72
	Choosing Recording Media When Shooting	75
	Copying Images	77
	Backing Up on External Media.....	78
8	Using GPS Devices	83
	Connecting GPS Devices with a USB Cable	84
	Connecting GPS Devices via Bluetooth.....	87
9	Troubleshooting	91
	Responding to Error Messages	92
	Wireless LAN Notes.....	106
	Checking Network Settings.....	107
10	Reference	109
	Creating and Registering Captions	110
	Specifications.....	111
	Index	118

Areas of Use and Restrictions

- To comply with local radio wave regulations in various areas around the world, Canon offers four region-specific versions of the transmitter (WFT-E2 IIA, E2 IIB, E2 IIC, and E2 IID) as described below. Please do not use your model (version) of transmitter in regions it was not designed for.

For information on other areas where the transmitter can be used, contact Canon Service Center.

Model (Version)	Area of Use	Wireless LAN Specification and Supported Channels	
WFT-E2 IIA	United States, Canada, Singapore, and Hong Kong	IEEE 802.11a	36 – 64 ch 149 – 165 ch
		IEEE 802.11b/g	1 – 11 ch
WFT-E2 IIB	Japan, France, Italy, Germany, United Kingdom, Belgium, the Netherlands, Luxembourg, Ireland, Denmark, Greece, Spain, Portugal, Austria, Finland, Sweden, Poland, Hungary, Romania, Bulgaria, Czech Republic, Slovakia, Slovenia, Estonia, Latvia, Lithuania, Cyprus, Malta, Iceland, Norway, Switzerland, Liechtenstein, Australia, New Zealand, Russia, and Hong Kong	IEEE 802.11a	36 – 64 ch 100 – 140 ch
		IEEE 802.11b/g	1 – 13 ch
WFT-E2 IIC	Mainland China and Hong Kong	IEEE 802.11a	149 – 161 ch
		IEEE 802.11b/g	1 – 13 ch
WFT-E2 IID	Can be used in all areas noted above	IEEE 802.11a	Not supported
		IEEE 802.11b/g	1 – 11 ch

- In France, outdoor use is prohibited.
- In mainland China, outdoor use requires a permit in some areas.

IEEE 802.11a Restrictions

When IEEE 802.11a wireless networking is used, channels in gray in the following table cannot be used. These restrictions are established by local regulations, which must be upheld. The transmitter can be used on channels in blue. Regarding channels in yellow, some restrictions apply. Refer to the footnotes.

		Wireless LAN Connection Method	Channel		
WFT-E2 IIA	Indoors	Infrastructure	36 – 48	52 – 64	149 – 165
		Ad hoc	36 – 48	52 – 64	149 – 165
	Outdoors	Infrastructure	36 – 48	52 – 64	149 – 165
		Ad hoc	36 – 48	52 – 64	149 – 165
WFT-E2 IIB	Indoors	Infrastructure	36 – 48	52 – 64	100 – 140
		Ad hoc	36 – 48	52 – 64	100 – 140
	Outdoors	Infrastructure	36 – 48	52 – 64 ^{*J}	100 – 140
		Ad hoc	36 – 48	52 – 64	100 – 140
WFT-E2 IIC			149 – 161 ^{*C}		

*J: In Japan, outdoor use on channels 52 – 64 is prohibited.

*C: In mainland China, outdoor use requires a permit in some areas.

- The following actions may be punishable under law. Disassembling or modifying the transmitter, or removing the certification label on it.
- Do not use the transmitter near other devices that emit radio waves, such as medical equipment or electronic devices. The transmitter may interfere with operation of these devices.
- Use the transmitter only with a compatible EOS DIGITAL camera. Using it with incompatible cameras may cause malfunction, accidents, and other problems not covered under warranty.
- Use the transmitter as a wireless or wired LAN device as described in this instruction manual. If you use the transmitter for any other purpose, Canon cannot be held liable for any loss or damage that may occur.

Safety Warnings

The following precautions are intended to prevent harm to you and others as well as damage to equipment. Become familiar with the precautions before using the transmitter to ensure correct and safe operation.

Warning Preventing Serious Injury or Death

- To prevent fire, excessive heat, chemical leakage, or explosion, follow these safety guidelines.
 - Do not insert metallic objects between electrical contacts of the transmitter, accessories, or connecting cables.
- Do not use the transmitter where there is flammable gas. There is a risk of explosion or fire.
- If the transmitter is dropped and internal parts are exposed, do not touch the exposed parts. There is a risk of electrical shock.
- Do not disassemble or modify the transmitter. High-voltage internal parts may cause electrical shock.
- Do not store the transmitter in dusty or humid places. There is a risk of fire or electrical shock.
- Before using the transmitter on board airplanes or in hospitals, make sure use is permitted. Electromagnetic waves emitted by the transmitter may interfere with instrumentation or medical equipment.

Caution Preventing Injury or Equipment Damage

- Do not leave the transmitter inside a vehicle in hot weather or near a heat source. The transmitter may become hot and cause burns if touched.
- Do not cover or wrap the transmitter with a cloth. This may trap heat inside, posing a risk of case deformation or fire.
- Do not use paint thinner, benzene, or other organic solvents to clean the transmitter. This poses a risk of fire and may be hazardous to your health.

If the product malfunctions, becomes damaged, or requires repair, contact your dealer or the nearest Canon Service Center.

Handling Precautions

- The transmitter is a precision instrument. Do not drop it or subject it to shock.
- The transmitter is not waterproof. Do not use it underwater.
- Wipe off any moisture with a clean, dry cloth. If the transmitter has been exposed to salty air, wipe it with a clean damp cloth after wringing it out to remove excess water.
- Never leave the transmitter near any equipment that generates a strong magnetic field, such as magnets or electric motors.
- Do not leave the transmitter in excessive heat, such as in a vehicle in direct sunlight. High temperature may damage the transmitter.
- Do not wipe the transmitter using cleaners containing organic solvents. If the transmitter becomes difficult to clean, take it to the nearest Canon Service Center.
- To avoid corrosion, do not store the transmitter where there are strong chemicals, such as in darkrooms or chemical labs.

Nomenclature

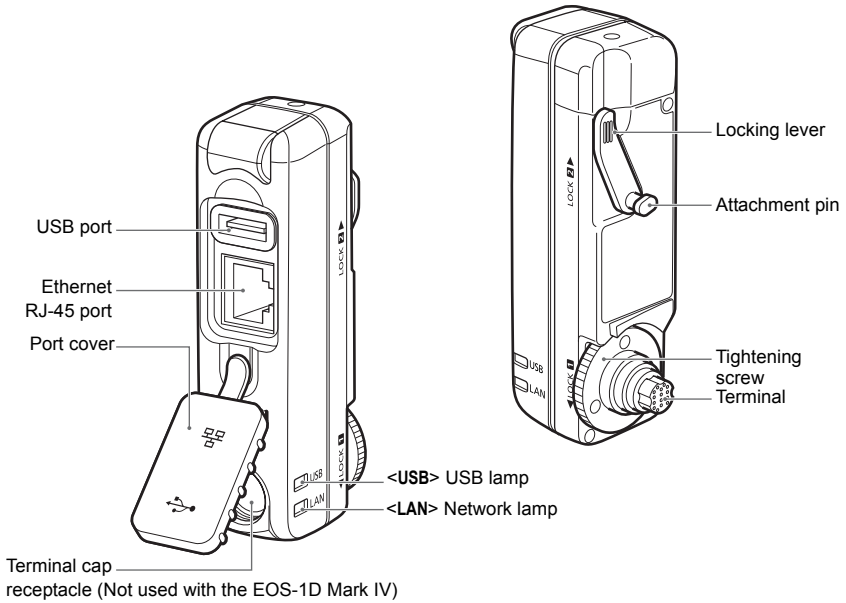

Transmitter Case

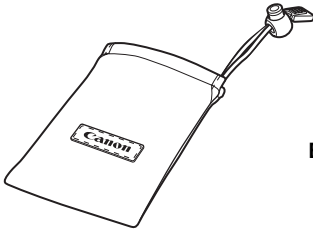

Waterproof/Dustproof USB Cap*2

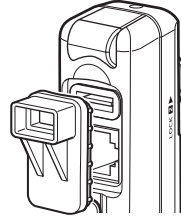

External Media Case*1

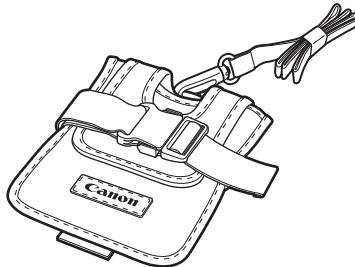

*1: For storing portable hard disks or other devices.

*2: Attach this cap before connecting the USB cable in rainy weather or under other adverse conditions.

Attaching to the Camera

Turn off the camera before attaching the transmitter.

Ensure the camera battery has sufficient charge. If the charge drops below 19%, you cannot transfer captured images or back them up to external media.

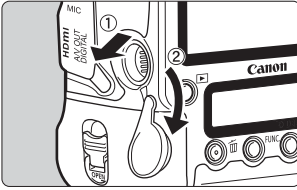

1 Open the terminal cover on the camera.

- Open the extension system terminal cover and turn it toward the bottom.

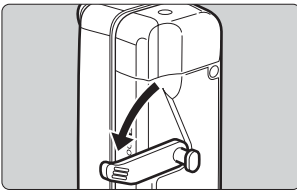

2 Move the lever into the release position.

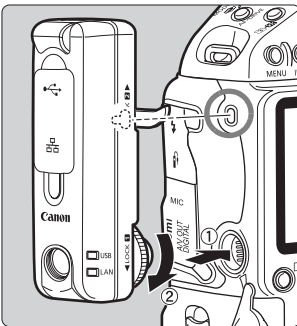

3 Attach the transmitter.

- Align the attachment pin with the WFT-E2 II/IIA mounting hole on the camera.
- Push the terminal firmly into the camera.
- As you push the terminal into the camera, turn the tightening screw until it stops rotating to attach the transmitter securely.

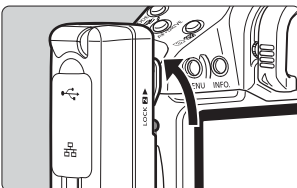

4 Move the lever into the locked position.

- The transmitter is now attached to the camera.
- The transmitter will be powered by the camera.

Removal

- Turn off the camera.
- Push the lever down, into the release position.
- Loosen the tightening screw until it spins freely.
- Pull the terminal out of the camera.

Subsequent Organization of This Manual

Click one of the following chapter titles to view the corresponding page.

1 Basic Network Settings (p.15)

2 Transferring Images to an FTP Server (p.29)

3 Remote Capture Using EOS Utility (p.43)

4 Remote Capture Using WFT Server (p.49)

5 Linked Shooting (p.61)

6 Managing Settings Information (p.65)

7 Using External Media (p.71)

8 Using GPS Devices (p.83)





Basic Network Settings

Complete the basic network settings by following transmitter connection instructions on the camera menu screen.

Getting Ready

[FTP trans.], [EOSUtility], [WFTserver]

The connection instructions help you follow the steps to connect the transmitter to an existing wireless or wired LAN.

To connect to a wireless LAN, prepare the wireless LAN terminal (wireless LAN access point or wireless LAN adapter) and computer in advance so that they are ready for you to connect the transmitter to the wireless network. When configuring the basic network settings, bring the transmitter within 3 m / 9.8 ft. of the wireless LAN terminal.

To connect to a wired LAN, use a LAN cable to connect the transmitter and computer. Set the transmitter for connection to the wired network.

Wireless Transmission of Movie

Individual movie files are large, and wireless file transmission takes some time. When setting up an environment for stable transmission to the wireless LAN terminal, refer to the information on page 106.

[LinkedShot]

Set up two or more EOS-1D Mark IV cameras with attached transmitters.

Displaying the Connection Wizard

This section describes the process of following the connection instructions. If an error is displayed, refer to "Troubleshooting" in Chapter 9 (p.91) and check the settings.

- Pressing the shutter button or other camera controls during configuration by the connection instructions will close the connection instructions. Do not press the shutter button or other controls until configuration is finished.
- On the [P] tab, set [Auto power off] to [Off]. If auto power off is activated, the connection instructions will be closed during the configuration process.

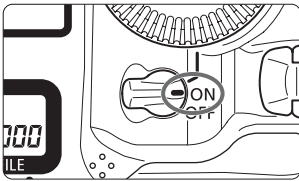

1 Turn the camera on.



2 Display the transmitter menu.

- On the camera, press the <MENU> button.
- On the [P] tab, select [WFT settings] and press <SET>. [WFT settings] is added to the tab after you attach the transmitter.

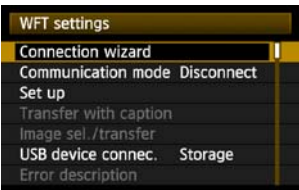

3 Select [Connection wizard].

- ▶ The [Select communication method] screen is displayed.

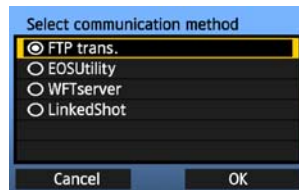

- ▶ The <LAN> lamp starts blinking.

Selecting the Communication Method and LAN Type ■

Selecting the Communication Method

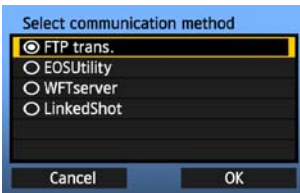

- Turn the <ⓘ> dial to select the communication method, and then press <SET>.
- Select [OK] and press <SET> to go to the next screen.

• FTP trans.

Choose this option to transfer captured images to an FTP server.

Images can be automatically transferred as you shoot them, or you can select images to be transferred later.

Computer Operating Systems

Operation via [FTP trans.] requires that Windows Vista (Business, Enterprise, or Ultimate Edition for 32- or 64-bit systems), Windows XP Professional, Windows 2000, or Mac OS X 10.4 or 10.5 be installed on your computer. In addition, the computer must be set up as an FTP server in advance.

For instructions on setting up your computer as an FTP server, refer to the computer documentation.

Windows Vista Home Premium and Home Basic Edition as well as Windows XP Home Edition cannot be used because FTP server functionality is not supported.

• EOSUtility

Choose this option for remote capture over a wireless or wired LAN using the EOS Utility software included with your camera.

In addition to remote capture, all camera operations in EOS Utility are supported. With this option, a wireless or wired network is used instead of the USB cable.

Requires a computer with EOS Utility (included with EOS-1D Mark IV cameras) installed.

• WFTserver

Choose this option for remote capture over a wireless or wired LAN with the transmitter acting as a server.

Additionally, images on a memory card in the camera can be viewed and downloaded to a computer.

The camera can be accessed like browsing a webpage, by users at up to three computers.

Computer Operating Systems

Any computer with a web browser can be used, regardless of the operating system.

Even devices other than computers can be used, if they feature a web browser. However, if the web browser does not support JavaScript, WFT Server functions will be limited. Also note that devices with limited performance may display images more slowly, and downloading images to these devices may not be possible.

• LinkedShot

Choose this option for linked shooting with multiple EOS-1D Mark IV cameras attached with transmitters. Up to 10 slave cameras can be linked to the master camera on which you will release the shutter. Note that there will be a slight delay after you release the master camera shutter before the slave cameras shoot. Movie shooting is not supported.

For further instructions on [LinkedShot], refer to page 61 of this manual.

Selecting the LAN Type

For [LinkedShot] instructions, refer to page 61. Note that no information about [LinkedShot] is given in this chapter.



- Turn the dial to select the type of LAN, and then press .
- Select [OK] and press to go to the next screen.

Wireless LAN

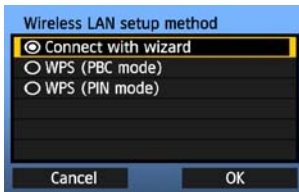

The [Wireless LAN setup method] screen is displayed.

[Connect with wizard]: See p.21

[WPS (PBC mode)]: See p.23

[WPS (PIN mode)]: See p.24

Select [WPS (PBC mode)] or [WPS (PIN mode)] when using a wireless LAN terminal compatible with Wi-Fi Protected Setup (WPS).

Wired LAN

The [Network] settings screen is displayed. If you have selected a wired network, refer to page 25, "Configuring Network Settings."

Use a Category 5 or higher STP LAN cable. (STP: Shielded Twisted Pair)

Using the Wizard to Establish a Connection

Selecting the Wireless Network

When you select **[Connect with wizard]**, active wireless LAN terminals in your area are listed, accompanied by information about them. Select the SSID (or ESS-ID) of your desired wireless LAN terminal.

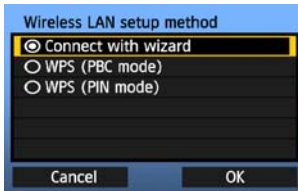

1

Select **[Connect with wizard]**.

- Turn the <⊙> dial to select **[Connect with wizard]**, and then press <SET>.

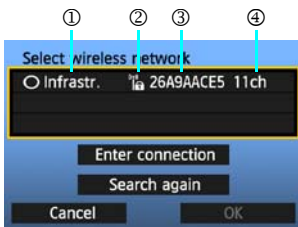

2

Select the wireless LAN terminal.

- To select the wireless LAN terminal, press <⊙>.
- Turn the <⊙> dial to select the wireless LAN terminal, and then press <SET>.
- Select **[OK]** and press <⊙> to go to the next screen.

- ① Indicates whether the device is in infrastructure or ad hoc mode
- ② An icon is displayed if the wireless LAN terminal is encrypting communication
- ③ Indicates the first 9 characters of the SSID
- ④ Indicates the channel used

Encryption by Wireless LAN Terminals

If the wireless LAN terminal is encrypting communication, select the corresponding method in **[Authentication]** and **[Encryption]**.

- **[Authentication]**: Open system, Shared key, WPA-PSK, or WPA2-PSK
- **[Encryption]**: WEP, TKIP, or AES

[Enter connection] and **[Search again]**

- To configure settings for the wireless LAN terminal manually, select **[Enter connection]** and press <SET>. Complete the settings for the items displayed, one after another.
- To search for wireless LAN terminals again, select **[Search again]** and press <⊙>.

Entering the Wireless LAN Encryption Key

Next, enter the encryption key of the wireless LAN terminal. For details on the encryption key, refer to the device's instruction manual.

Note that the screens displayed in steps 1 to 3 below vary depending on the authentication and encryption of the wireless LAN terminal.

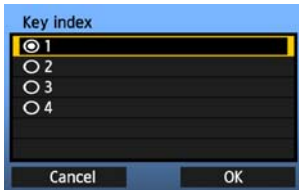

1

- The **[Key index]** screen is displayed only if WEP encryption is used by the wireless LAN terminal.
- Turn the <◂> dial to select the key index number specified as the access point, and then press <SET>.
- Select **[OK]** and press <SET> to go to the next screen.

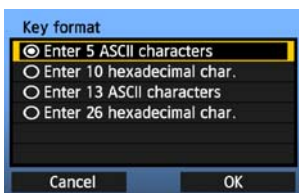

2

- Turn the <◂> dial to select the key format, and then press <SET>.
- Select **[OK]** and press <SET> to go to the next screen.

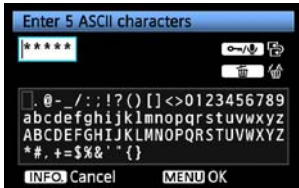

3

- Enter the encryption key.
- To switch between input areas, press the <⇄> button.
- To move the cursor, turn the <◂> dial.
- In the bottom input area, turn the <◂> dial and press <SET> to enter the encryption key.
- If you make a mistake, press the <⏮> button to erase it.
- When you press the <MENU> button to complete the connection with the wireless LAN terminal, the **[Network]** screen (p.25) is displayed.
- To return to the previous screen, press the <INFO.> button. The entry is erased.

WPS Connections (PBC Mode) ■

This is a connection mode when using a wireless LAN terminal compatible with Wi-Fi Protected Setup (WPS). Pushbutton Connection mode (PBC mode) makes it easy to establish a connection between the camera and the wireless LAN terminal by pressing the WPS button on the wireless LAN terminal.

Note that if multiple wireless LAN terminals are active in your area, it may be harder to establish a connection. In this case, try using **[WPS (PIN mode)]** to establish a connection.

Confirm the position of the WPS button on the wireless LAN terminal in advance.

It may take about one minute to establish connection.

Connection may not be possible if stealth functions are enabled on the wireless LAN terminal. Deactivate stealth functions.

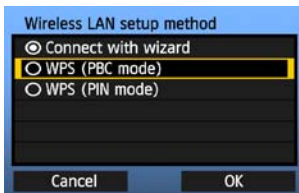

1 Select **[WPS (PBC mode)]**.

- Turn the <⊙> dial to select **[WPS (PBC mode)]**, and then press <ⓈET>.
- Select **[OK]** and press <ⓈET> to go to the next screen.



2 Establish a connection with the wireless LAN terminal.

- Press the WPS button on the wireless LAN terminal. For details about where the button is located and how long to press it, refer to the instruction manual of the wireless LAN terminal.
- Select **[OK]** and press <ⓈET> to establish a connection with the wireless LAN terminal.
- When the connection with the wireless LAN terminal is established, the **[Network]** screen (p.25) is displayed.

WPS Connections (PIN Mode)

This is a connection mode when using a wireless LAN terminal compatible with Wi-Fi Protected Setup (WPS). In PIN code connection mode (PIN mode), an 8-digit identification number specified on the camera is set on the wireless LAN terminal to establish a connection.

Even if there are multiple wireless LAN terminals active in your area, this is a relatively reliable method of establishing a connection using a shared identification number.

It may take about one minute to establish connection.

Connection may not be possible if stealth functions are enabled on the wireless LAN terminal. Deactivate stealth functions.

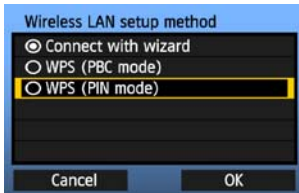

1 Select [WPS (PIN mode)].

- Turn the  dial to select [WPS (PIN mode)], and then press <SET>.
- Select [OK] and press <SET> to go to the next screen.

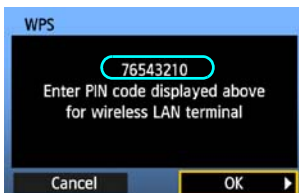

2 Specify the PIN code on the wireless LAN terminal.

- On the wireless LAN terminal, specify the 8-digit PIN code shown on camera LCD monitor.
- For instructions on setting PIN codes on the wireless LAN terminal, refer to the instruction manual of the wireless LAN terminal.
- Select [OK] and press <SET> to display the confirmation screen.

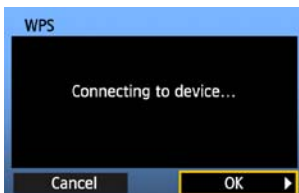

3 Establish a connection with the wireless LAN terminal.

- Select [OK] and press <SET> to establish a connection with the wireless LAN terminal.
- When the connection with the wireless LAN terminal is established, the [Network] screen (p.25) is displayed.

Configuring Network Settings

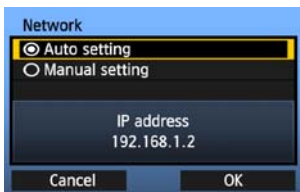

- Turn the <⌂> dial to select how to configure the network settings, and then press <SET>.
- Select [OK] and press <SET> to go to the next screen.

[Auto setting]

- Settings otherwise configured with [Manual setting] can be configured automatically. However, the IP address and similar settings must be automatically assigned and configured in environments using DHCP servers or wireless LAN terminals or routers supporting DHCP server functions. If an error is displayed, select [Manual setting] regardless of whether the IP address and similar settings are automatically assigned and configured.

[Manual setting]

The [IP address set.] screen is displayed after you select [Manual setting]. If [Auto setting] results in an error, enter the IP address manually. As the IP address, enter the IP address assigned to the camera.

Enter the [IP address], [Subnet mask], [Gateway], and [DNS address] on each screen as they are displayed.

If you are not sure what to enter, refer to page 107, “Checking Network Settings,” or ask the network administrator or another person knowledgeable about the network.

- When entering numbers for the IP address, subnet mask, and so on, press <SET> to move the input position and turn the <⌂> dial to enter the number.

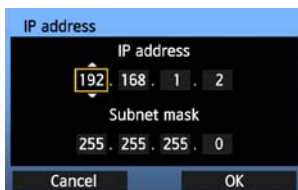
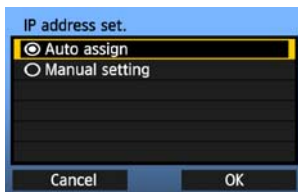

Completing Settings for the Communication Method

The following instructions are for settings screens that vary depending on the communication method (FTP Transfer, EOS Utility, or WFT Server), as shown below. Read the page that introduces the selected communication method.

FTP trans.

Chapter 2 (p.29)

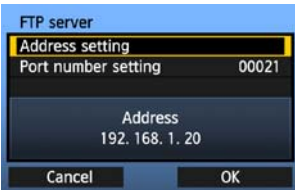

EOSUtility

Chapter 3 (p.43)



Windows Vista Users

Before performing the operations from page 43, perform the operations below. If these operations are not performed, the WFT Pairing Software described on page 44 may not start.

Open the [C Drive] → [Program Files] → [Canon] → [EOS Utility] → [WFTPairing] folder (in this order), and then double-click the [WFT FirewallSettings] icon.

After performing this operation, perform the operation on page 43.

WFTserver

Chapter 4 (p.49)

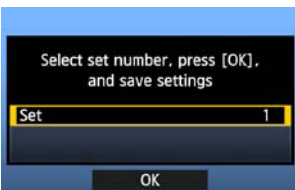

Virtual Keyboard Operation

The virtual keyboard is displayed during entry of the encryption key, server name, and other information.



Switching to other input areas

To switch between input areas, press the <↔/🗑️> button.

Moving the cursor

To move the cursor, turn the <🕒> dial.

You can also move the cursor using <⬅️/➡️>.

Entering text

In the bottom input area, turn the <🕒> dial to move the cursor and press <⏎️> to enter text.

You can also move the cursor using <⬅️/➡️>.

Deleting text

If you make a mistake, press the <🗑️> button to erase it.

Confirming entries

Press the <MENU> button to confirm what you have entered and go to the next screen.

Canceling entries

Press the <INFO.> button to erase the entry and return to the previous screen.



2

Transferring Images to an FTP Server

With FTP transfer, you can automatically transfer each image to the FTP server as you shoot or transfer a set of shots together.

Configuring FTP Communication Settings

These instructions are continued from Chapter 1.

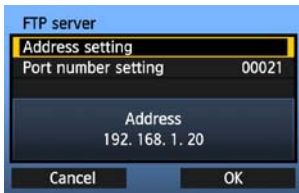

1

- Turn the <⊙> dial to select **[Address setting]**, and then press <SET>.



2

- If you have set the DNS server setting to **[Disable]**, the screen at left is displayed.
- Press <SET> to select the input position, and then turn the <⊙> dial to enter the IP address of the FTP server.



- If you have set the DNS server IP address setting to **[Auto assign]** or **[Manual setting]**, the screen at left is displayed.
- For instructions on screen operations, refer to "Virtual Keyboard Operation" (p.27).
- Enter the FTP server's server name or IP address.

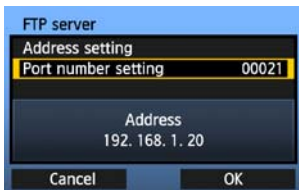

3

- In **[Port number setting]**, enter 00021, in most cases.
- Turn the <⊙> dial to select **[OK]**, and then press <SET> to go to the next screen.

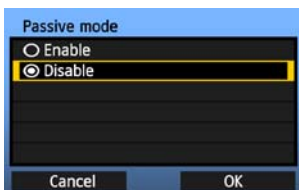

4

- Complete the **[Passive mode]** settings.
- If an Error 41 ("Cannot connect to FTP server") is displayed in step 8, setting **[Passive mode]** to **[Enable]** may resolve it.

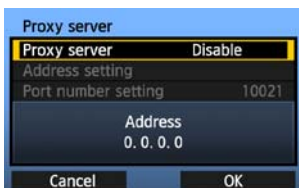

5

- Complete the **[Proxy server]** settings.
- Turn the <⊙> dial to select **[OK]**, and then press <SET> to go to the next screen.



6

- Complete the [**Login method**] settings.
- Turn the <⊙> dial to select [**OK**], and then press <SET> to go to the next screen.

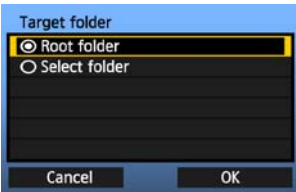

7

- Complete the [**Target folder**] settings.
- Select [**Root folder**] to have images saved in the root folder as specified in FTP server settings. (p.41)
- Select [**Select folder**] to specify a subfolder in the root folder. If no folder exists, a folder will be created automatically.
- Turn the <⊙> dial to select [**OK**], and then press <SET> to connect to the FTP server.



8

- On the confirmation screen displayed next, select [**OK**] and press <SET>.
- ▶ The <LAN> lamp is lit in green.

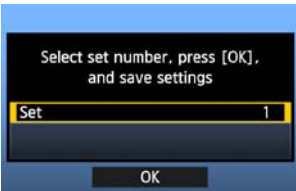

9

- Press <SET>. Turn the <⊙> dial to select the set number, and then press <SET>.
- Turn the <⊙> dial to select [**OK**], and then press <SET>. After the connection wizard is closed, the display reverts to the menu screen.



- Settings information is stored on the camera. It is not stored on the transmitter.

The network settings for FTP transfer are now complete.

Automatic Image Transfer After Each Shot

An image can be automatically transferred to the FTP server immediately after shooting. You can also continue shooting even while images are being transferred.

Before shooting, be sure to insert a memory card in the camera or connect external media (p.71). If you shoot without recording images, they cannot be transferred.

Note that automatic transfer of movie is not supported. Transfer the movie after shooting, as described on pages 35-39.



1 In [WFT settings], select [Set up].

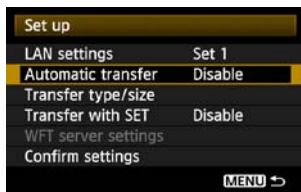

2 Select [Automatic transfer].

- Select [Enable].

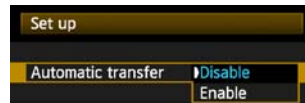

3 Take the picture.

- ▶ The captured image is transferred to the FTP server.
- During image transfer, the <LAN> lamp blinks.



- During continuous shooting, images are transferred to the FTP server in the order they are captured.
- The captured images are also stored on the memory card.
- Any images for which transfer fails or is interrupted can be transferred later together.

Selecting Particular Sizes or Types of Images to Transfer

In automatic transfer during shooting, you can choose which images to transfer if different sizes of images are recorded to the memory card and external media, or during RAW+JPEG shooting.



1 In [WFT settings], select [Set up].

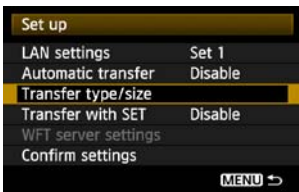

2 Select [Transfer type/size].

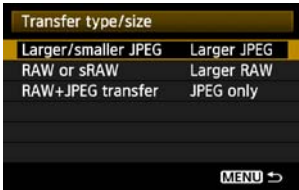

3 Select the size and type of images to transfer.

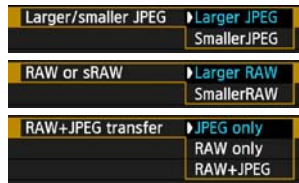

- If the camera is set up to record larger JPEGs on a CF card and smaller JPEGs on an SD card and you want to transfer the smaller JPEGs, set [Larger/smaller JPEG] to [Smaller JPEG].
- If the camera is set up to record RAW images on a CF card and JPEGs on an SD card, specify which images to transfer in the [RAW+JPEG transfer] setting. Similarly, complete the same setting if RAW+JPEG images are recorded simultaneously on a single memory card.
- If images of the same size are recorded on a CF card, SD card, and external media at the same time, images recorded on the CF card are transferred, regardless of the image quality (compression).

Transferring Images Individually

Simply select an image and press <SET> to transfer it. You can also add a caption before transferring images. You can also continue shooting even while images are being transferred.

Transferring the Current Image



1 In [WFT settings], select [Set up].

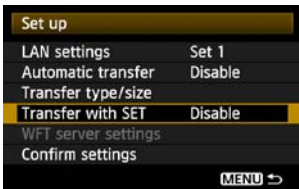

2 Select [Transfer with SET].

- Select [Enable].

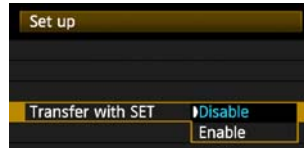

3 Select the image.

- On the camera body, press the <▶> button.
- Select the image to transfer, and then press <SET> to transfer the image.
- **Movie cannot be transferred this way. Selecting movie and pressing <SET> will display the movie playback panel.**

Adding a Caption Before Transfer

You can add a registered caption to each image before transfer. This is effective if you want to inform the recipient the printing quantity, for example. The caption is also added to images stored on the camera.

For instructions on creating and registering captions, refer to page 110.

You can check for captions added to images by examining the Exif information, in the user comments.

1 Take the picture.

2 In [WFT settings], select [Transfer with caption].

- ▶ The last captured image is displayed.



- It is not possible to select other images on the [Transfer with caption] screen. To select another image for transfer with a caption, view that image before following these steps.

3 Select a caption.

- Turn the <◂> dial to select the [Caption] frame, and then press <SET>.
- Turn the <◂> dial to select the content of the caption, and then press <SET>.

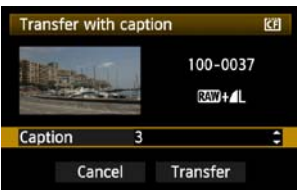

4 Transfer the image.

- Turn the <◂> dial to select [Transfer], and then press <SET>.

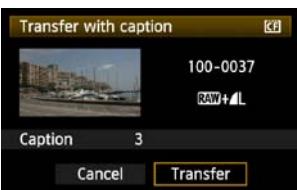

I If you add captions to images that include original decision data, these images are no longer judged to be original images.

Batch Transfer

After shooting, you can select multiple images as desired and transfer them all at once. You can also transfer unsent images or images that could not be sent previously.

If both a CF card and SD card are used at the same time, or if external media is connected, images are transferred from the source specified on the menu [F] tab, in [Record func+media/folder sel.] → [Record/play].

You can also continue shooting even while images are being transferred.

Selecting Images to Transfer



1 In [WFT settings], select [Image sel./transfer].



2 Select [Sel. Image].
▶ An image is displayed.



3 Select images to transfer.

- Press <SET>. Turn the <DISP> dial to display <✓> in the upper left corner of the image to transfer.
- Press <SET> to confirm your selection.
You can select up to 9,999 images.
- Press the <Q> button to display three images per screen. Press the <Q> button to display one image per screen again.



- After selecting images to transfer, press the <MENU> button.



4 Transfer the images.

- Select [Transfer].
- Select [OK] on the confirmation screen displayed next.
- ▶ A transfer progress screen is displayed.



- During image transfer, the <LAN> lamp blinks.

Menu Operation During Image Transfer

You can use the menu even during image transfer. However, to prevent transfer problems, some menu items are unavailable during transfer, including [WFT settings], [Protect images], [Erase images], [Format], and [Record func+media/folder sel.].

Batch Transfer of Images in a Folder



1 In [WFT settings], select [Image sel./transfer].



2 Select [Sel.].



3 Select [Folder images not transfer'd].

- To transfer images that could not previously be transferred, select [Folder images failed transf.].



4 Select a folder.

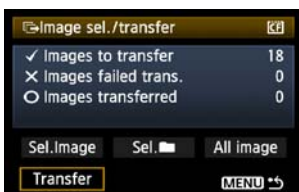

5 Transfer the images.

- Select [Transfer].
- Select [OK] on the confirmation screen displayed next.
- ▶ A transfer progress screen is displayed.
- During image transfer, the <LAN> lamp blinks.

Selecting [Clear folder transf. history] will set the transfer history of images in the selected folder to "unsent." This enables you to resend all the images in the folder later by selecting [Folder images not transfer'd].

Batch Transfer of Images on memory Cards



1 In [WFT settings], select [Image sel./transfer].

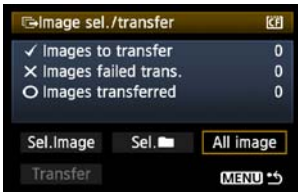

2 Select [All image].

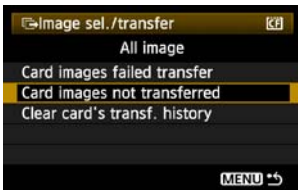

3 Select [Card images not transferred].

- To transfer images that could not previously be transferred, select [Card images failed transfer].

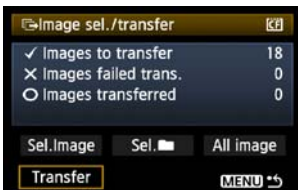

4 Transfer the images.

- Select [Transfer].
- Select [OK] on the confirmation screen displayed next.
- ▶ A transfer progress screen is displayed.
- During image transfer, the <LAN> lamp blinks.



Selecting [Clear card's transf. history] will set the transfer history of images on the memory card to "unset." This enables you to resend all the images on the card later by selecting [Card images not transferred].

Checking Image Transfer History

Checking the Transfer History of Individual Images

To check the transfer history, in [Image sel./transfer], select [Sel.Image].

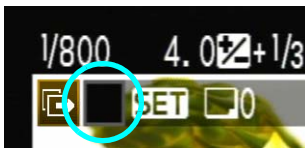

Image not selected for transfer (no icon)

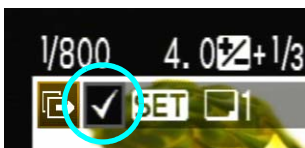

Image selected for transfer

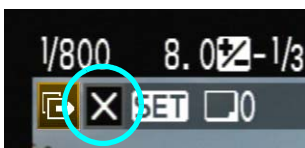

Image could not be transferred

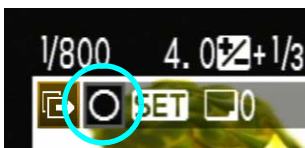
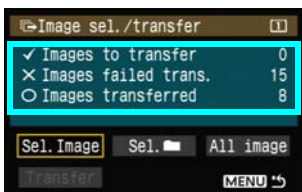

Image transferred

Checking the Transfer History of Folders or Memory Cards



On the [Image sel./transfer] screen, you can check the number of images for transfer as well as the transfer history of images in the selected folder or memory card. Specifically, you can check the number of images classified as [Images failed trans.] and [Images transferred].

Viewing Transferred Images

Images transferred to the FTP server are stored in the following folder as specified in the FTP server settings.

Windows

- Under the default settings of the FTP server, images are stored in **[C drive]** → **[Inetpub]** folder → **[ftproot]** folder, or in a subfolder of this folder.
- If the root folder of the transfer destination has been changed in the FTP server settings, ask the FTP server administrator where images are transferred.

Macintosh

- Open the **[Macintosh HD]** → **[Users]** folder. The folder where images are stored is located in the folder of the user currently logged on, or in a subfolder there.

Folders for Image Storage

Under the default transmitter settings, transferred images will be stored in the root folder specified in the FTP server settings, in a folder structure such as *A/DCIM/100EOS1D* which is automatically created.

Additionally, if you have selected a CF card as the media for recording and playback, a folder structure such as “*A/DCIM/100EOS1D*” is automatically created for image storage. For an SD card, “*B/DCIM/100EOS1D*” is created, and for external media, “*C/DCIM/100EOS1D*” is created. (CF card images are assigned to the A folder, SD card images to the B folder, and external media images to the C folder.)



3

Remote Capture Using EOS Utility

You can use EOS Utility to shoot remotely over a wireless or wired LAN. In addition to remote capture, all camera operations in EOS Utility are supported because a wireless or wired network is used with this option instead of the USB cable.

Configuring EOS Utility Communication Settings

These instructions are continued from Chapter 1.

With EOS Utility, you can use the included WFT Pairing Software to establish a connection between the transmitter and a computer.

WFT Pairing Software is installed automatically during easy installation of the software provided with the camera. If it is not installed, install it on the computer for communication with the transmitter before this procedure.

The configuration procedure is as follows, using Windows XP as an example.



1

- First, the pairing screen is displayed.
- Turn the < > dial to select [OK]. When you press < (SET) >, the following message is displayed. Here, ***** represents the last six digits of the MAC address of the WFT-E2 II for the connection.



2

- Start the pairing software.
- Normally, it is installed in the same location as EOS Utility.

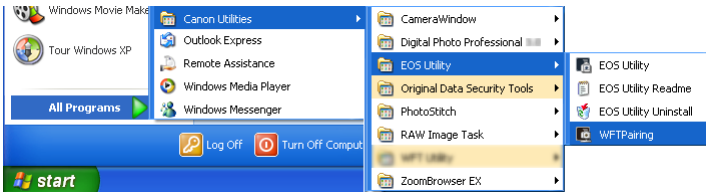

- ▶ After the pairing software starts up, an icon is displayed in the task bar.
- ▶ When the camera is detected, a message is displayed.

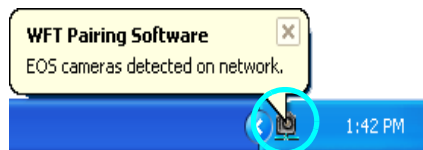

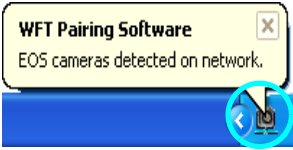

3

- Double-click the pairing software icon.
- ▶ Detected cameras are listed. Cameras that have already been connected are not included in the list.

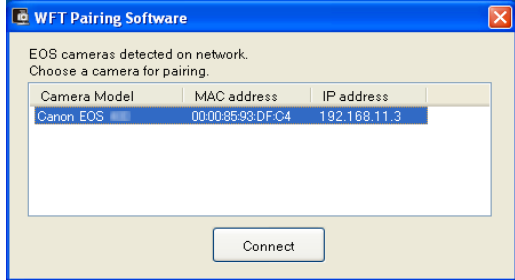

- Click [**Connect**].
- If multiple cameras are displayed, identify the camera to connect to by its [**MAC address**] or [**IP address**].
- You can check the [**MAC address**] and [**IP address**] by accessing [**Confirm settings**] in the menu (p.66).

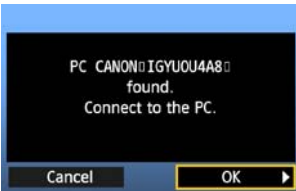

4

- When the camera detects the computer on which you clicked [**Connect**] in step 3, the message at left is displayed.
- Turn the <OK> dial to select [**OK**], and then press <SET>.

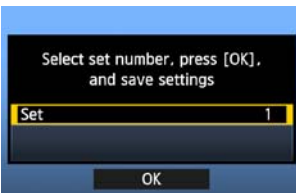

5

- Press <SET>. Turn the <OK> dial to select the set number, and then press <SET>.
- After you turn the <OK> dial to select [**OK**] and press <SET>, the connection wizard is closed and EOS Utility starts up.
- ▶ The <LAN> lamp on the transmitter is lit in green.
- Settings information is stored on the camera. It is not stored on the transmitter.

The EOS Utility network settings are now complete.

- There is no need to complete pairing again if you will continue using a particular camera, transmitter, and computer together after pairing without changing the settings. Before your next PTP session, simply turn on the camera to which the transmitter is attached and start the pairing software. The connection between the camera and computer will be established automatically.
- You can add the pairing software to the software launched at startup of your computer. In EOS Utility on the **[Preferences]** → **[Basic Settings]** tab, select [**Add WFT Pairing Software to the Startup folder**].

Using EOS Utility

For EOS Utility instructions, refer to the Software Instruction Manual (PDF). You can take full advantage of EOS Utility via the transmitter just as via a USB connection, without restrictions.



 In Remote Live View shooting, the rate of image transmission is slower than via USB. The motion of moving subjects cannot be displayed smoothly.



4

Remote Capture Using WFT Server

Using a web browser, you can view images on a memory card in the camera and download them to a computer.

Additionally, you can shoot remotely over a wireless or wired LAN. Note that bulb and movie shooting are not supported.

Configuring WFT Server Communication Settings ■

These instructions are continued from Chapter 1.

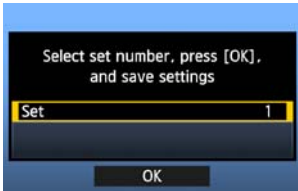

- Press <SET>. Turn the <⦿> dial to select the set number, and then press <SET>.
- Press <SET> again. After the connection wizard is closed, the display reverts to the menu screen.
- ▶ The <LAN> lamp on the transmitter is lit in green.

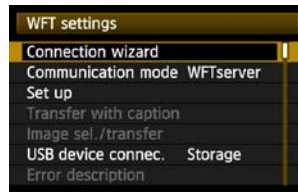

- Settings information is stored on the camera. It is not stored on the transmitter.

Setting up an Account

Enter a logon name and password for accessing the camera from a computer. The logon name and password you specify here are used on the computer when connecting to the camera.

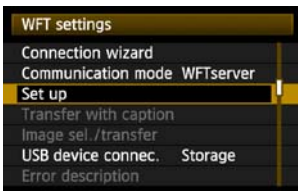

1

- Turn the <⦿> dial to select [Set up], and then press <SET>.

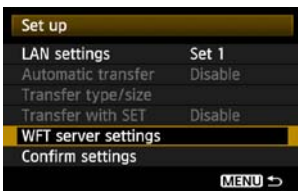

2

- Turn the <⦿> dial to select [WFT server settings], and then press <SET>.

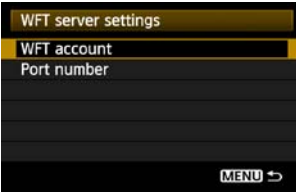

3

- Turn the <⊙> dial to select [**WFT account**], and then press <Ⓜ>.
- When changing the port number, turn the <⊙> dial to select [**Port number**] and press <Ⓜ>. Note that there is normally no need to change the port number (80).

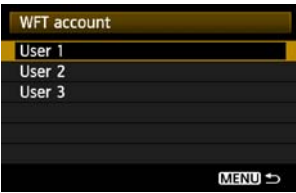

4

- Select a user number.
- With WFT Server, you can connect the camera to up to three computers. Here, select a user number to prevent conflicts when users at other computers are connected to the transmitter simultaneously.
- Turn the <⊙> dial to select [**User ***], and then press <Ⓜ>.

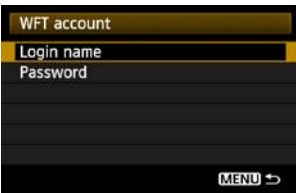

5

- After you select [**Login name**] and [**Password**], the following input screen is displayed.
- For instructions on input screen operations, refer to “Virtual Keyboard Operation” (p.27).



The WFT Server network settings are now complete.

Displaying WFT Server

In the web browser, display WFT Server, a screen for transmitter operations. Make sure you have already established a connection between the camera and computer.

1 Start the web browser.

- First, start Internet Explorer or another web browser.



2 Enter the URL.

- In the address field, enter the IP address assigned to the camera.
- Press the <Enter> key.



3 Complete the [Login name] and [Password] settings.

- Enter the login name and password as specified in the procedure on page 51. Click [OK] to display the WFT Server screen.
- Web browsers that support JavaScript now display the screen on the left below step 4. Otherwise, a message is displayed if JavaScript is not supported. Choosing not to use JavaScript will display the screen on the right below step 4, with limited functions.

4 Select the language.

- Select a language at the bottom of the screen.

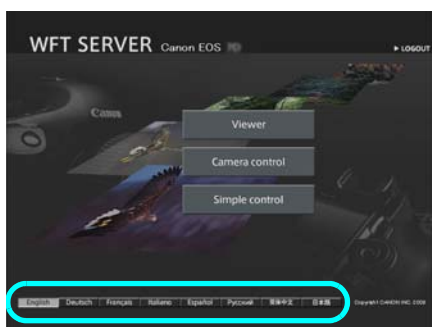

JavaScript supported

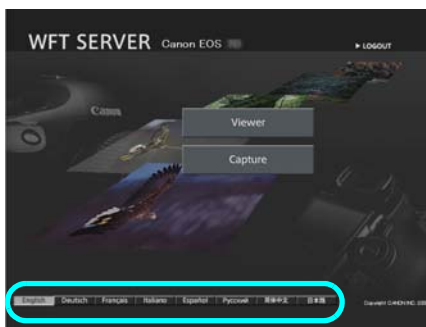

JavaScript not supported



If you don't know the URL (IP address)

You can check the URL (IP address) by accessing [Confirm settings] in the menu (p.66).

Viewing Images

Browse images on the camera's memory card as follows.

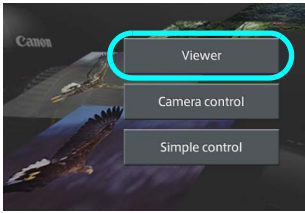

1

Click [Viewer].

- ▶ The image viewing screen is displayed.

2

Select the memory card.

- Click [CF], [SD], or the external media.
- Click the [DCIM] folder and select the folder containing the images.

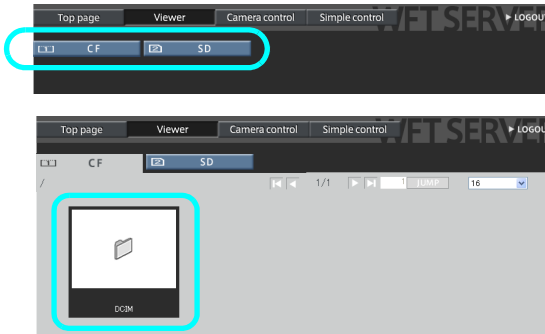

3

Select an image.

- To view another image, click the < [Left Arrow] [Right Arrow] > buttons or jump to other pages.
- In JavaScript-compatible web browsers, you can specify how many thumbnails are shown per screen by clicking the pull-down list in the upper-right corner of the screen.

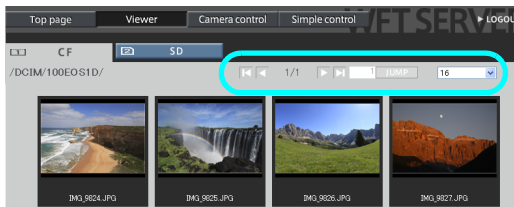

4 Download images to the computer.

- Click a thumbnail.
- ▶ The image is displayed at a larger size.
- To download the image to your computer, click .
- Click **[Return]** to return to the image viewing screen.

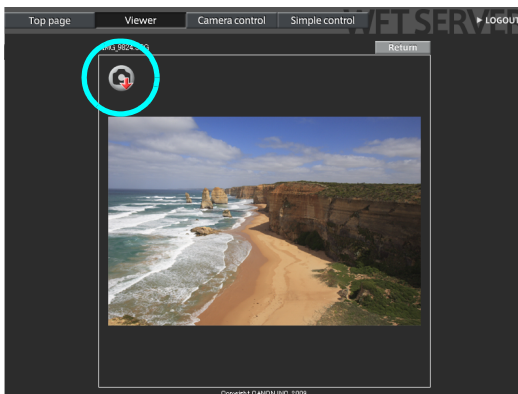

Although actual RAW images and movies are not displayed here, they can be downloaded to the computer the same way as JPEGs.

Remote Capture [Camera control]

First, prepare the camera for Live View shooting. Note that remote capture of movies is not supported.

For web browsers that do not support JavaScript, refer to page 59, "Remote Capture."

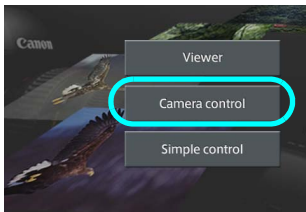

1

Click [Camera control].

▶ The advanced capture screen is displayed.



①	Battery check
②	Drive mode
③	Possible shots
④	AF mode
⑤	Release button
⑥	AF/MF switch
⑦	Shutter speed
⑧	Aperture
⑨	ISO speed
⑩	Exposure compensation

⑪	Quality
⑫	Shooting mode
⑬	White balance
⑭	Metering mode
⑮	Menu
⑯	Live View shooting button
⑰	Manual focus button
⑱	Live View image screen

* Shaded items cannot be configured via WFT Server. ② and ④ are configured on the camera itself.

2 Set the lens focus mode switch to <AF>.

- Under these conditions, click the release button (⑤). When you let go of the mouse button, the camera autofocuses and shoots. (See step 5.)
- With One-Shot AF, the camera does not shoot unless focus is achieved. Try following the next steps to display Live View image and shoot after manually focusing.



3 Display Live View image.

- Click the Live View shooting button (⑩).
- ▶ The AF/MF switch (⑥) is set to <MF>, and Live View image is displayed.
- If Live View image is not displayed, enable Live View shooting in the menu (⑮).

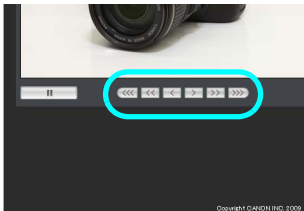

4 Manually adjust the focus.

- Click the buttons <◀◀◀>, <◀◀>, <◀>, <▶>, <▶▶>, and <▶▶▶> to adjust the focus. Note that autofocus is not supported during Live View image display.
- To focus more closely, click <◀◀◀>, <◀◀>, or <◀>. To focus farther away, click <▶>, <▶▶>, or <▶▶▶>.
- Three levels of focus adjustment are available.
- <◀◀◀> <▶▶▶> : Largest increment
<◀◀> <▶▶> : Intermediate increment
<◀> <▶> : Smallest increment

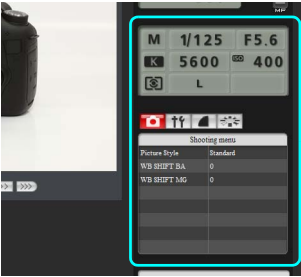

5 Configure the shooting settings.

- Click setting items (such as quality) to view the setting details, which you can configure.
- Complete the settings as needed.

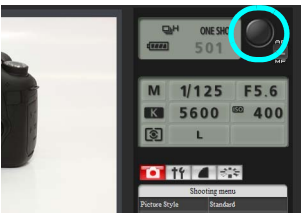

6 Take the picture.

- Click the release button (Ⓢ). When you let go of the mouse button, the camera shoots.
- ▶ The captured image is now displayed.
- Captured images are stored on the memory card.
- To download images to your computer, refer to page 53, and use the **[Viewer]** function.



The Live View image may freeze when shooting if the camera is accessed by multiple computers.

Remote Capture

The following instructions are for remote capture with web browsers that do not support JavaScript.

First, prepare the camera for Live View shooting. Note that remote capture of movies is not supported.

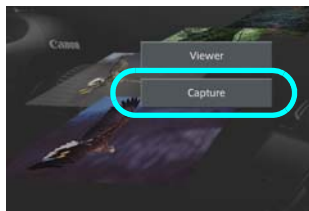

1 Click [Capture].

- ▶ The capture screen is displayed.
- Live View image is not displayed.

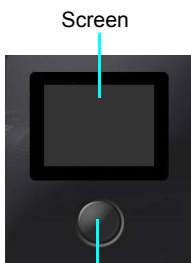

2 Take the picture.

- Set the lens focus mode switch to <MF>. Adjust the focus on the camera.
- Click the release button. When you let go of the mouse button, the camera shoots.
- ▶ The captured image is now displayed.
- Captured images are stored on the memory card.



3 Download images to the computer.

- Click the image.
- ▶ The image is displayed at a larger size.
- To download the image to your computer, click .
- Click [Return] to return to the capture screen.

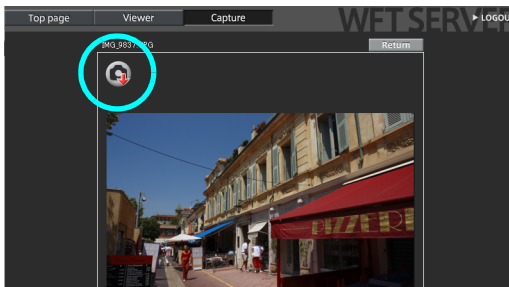

Although actual RAW images are not displayed here, they can be downloaded to the computer the same way as JPEGs.



5

Linked Shooting

With linked shooting, up to 10 slave cameras can be linked in a wireless network (via IEEE 802.11g in ad hoc mode) to the master camera on which you will release the shutter. Any cameras compatible with linked shooting, when they have WFT series transmitters attached, can be used as slave cameras, regardless of model.

Note that there will be a slight delay after you release the master camera shutter before the slave cameras shoot. Movie shooting is not supported.



Master camera

Setting Up Linked Shooting

First, establish a connection from the slave cameras to the master camera. Because linked shooting utilizes a wireless connection via IEEE 802.11g in ad hoc mode, it is not available over wired LANs.



1 Display the transmitter menu.

- On the camera, press the <MENU> button.
- On the [**WFT**] tab, select [**WFT settings**] and press <SET>. [**WFT settings**] is added to the tab after you attach the transmitter.

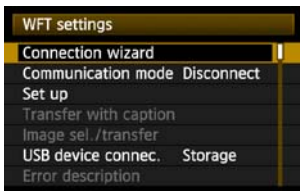

2 Select [Connection wizard].

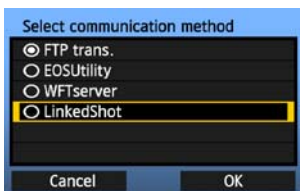

3 Select [LinkedShot].

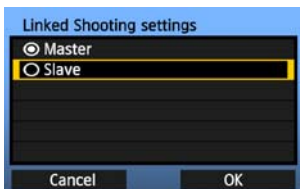

4 Set up the slave cameras.

- Select [**Slave**].
- ▶ The slave cameras are now ready, with the following screen displayed.

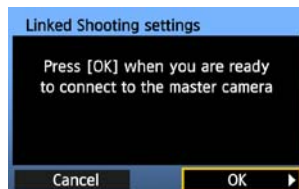

- When using multiple slave cameras, set up all slave cameras to slave state.
- Once the settings are complete, slaves cannot be added or removed. You must repeat the setup process from step 1.

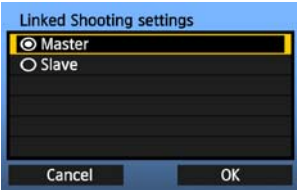

5 Set up the master camera.

- Configure the settings on the master camera following steps 1-3 on the previous page, and then select **[Master]**.
- ▶ The following screen is displayed.

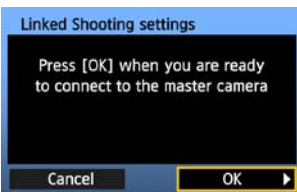

6 At this point, switch to setting up the slave cameras.

- On the slave cameras, select **[OK]**.

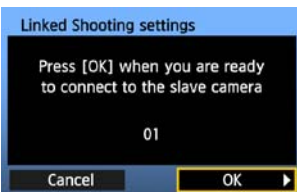

7 Check the number of slave cameras.

- ▶ On the master camera LCD monitor, the number of slave cameras detected is displayed.

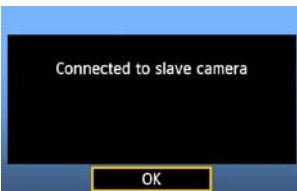

8 Establish the connection.

- On the master camera and all slave cameras, select **[OK]**.
- ▶ A screen is displayed as the connection is tested.
- The information you specified is stored on the cameras. It is not stored on the transmitters.



Arranging the Slave Cameras

Slave camera



Slave camera

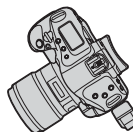

Slave camera



Master camera

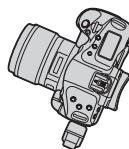

Slave camera

- Arrange the slave cameras in clear view of the master camera, without objects between them.
- You can arrange master camera in an overall circumference of up to approximately 100 m / 328 ft. However, the distance supported for linked shooting may be shorter depending on the wireless communication conditions, which are affected by how the cameras are arranged, the environment of use, and weather conditions.
- Pressing the shutter button halfway on the master camera puts slave cameras in the same state, as if the shutter buttons were pressed halfway. Similarly, fully pressing the shutter button on the master camera has the same effect on slave cameras, which respond as if the shutter buttons were fully pressed.
- There will be a slight delay after you release the master camera shutter until the slave camera shutters are released. (Simultaneous capture is not possible.)



When the master or slave camera's [**C.Fn III-17: Mirror lockup**] is set to [1: Enable] or [2: Enable: Down with SET (button)], linked shooting is not possible.



- During linked shooting, when you press the AE lock or depth-of-field preview button, the camera focuses and meters as if you had pressed the shutter button halfway.
- Once you have established a connection between the master camera and slave cameras, the settings are retained even after you replace the batteries.
- If you will no longer use a slave camera in linked shooting, set [**Communication mode**] to [**Disconnect**] on that slave camera.
- Any cameras compatible with linked shooting, when they have WFT series transmitters attached, can be used as slave cameras, regardless of model.

6

Managing Settings Information

Checking Settings

Check the network settings as follows.



1 In [WFT settings], select [Set up].

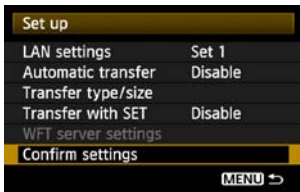

2 Select [Confirm settings].
▶ The settings are displayed.

Example of FTP transfer and wired LAN settings

Example of FTP transfer and wireless LAN settings

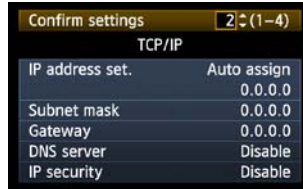
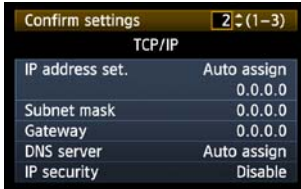
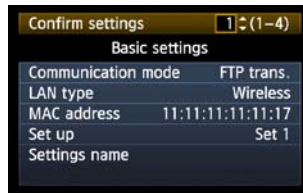

Changing Settings

Settings originally completed using the connection wizard can be changed as follows. You can also change IP security settings (IPsec) not completed using the connection wizard, as well as other settings, such as the setting that determines what happens if an image of the same file name as an existing file is sent to the FTP server. (p.68)

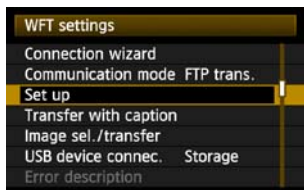

1 In **[WFT settings]**, select **[Set up]**.



2 Select **[LAN settings]**.



3 Select the settings number.

- Here, select the settings number that identifies the LAN settings.



4 Select **[Change]**.

- After selecting **[Change settings name]**, you can rename the settings.

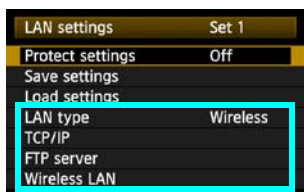

5 Select the item to change.

- Select the desired item from **[LAN type]**, **[TCP/IP]**, **[FTP server]**, or **[Wireless LAN]** and change the setting.

IP Security (IPsec)

Configured in [TCP/IP] → [Security].

IPsec is a set of standards for encrypted communication over the Internet. It provides effective security for both wireless and wired LANs. To use this function, you must enable IPsec in the network settings of your computer. When IPsec is employed, only transport mode is supported, and DES encryption and SHA1 authentication are used. Note that the IP address of the computer for communication with the transmitter must be entered in [Destination address] on the settings screen.

Directory Structure of the Target Folder

Configured in [FTP server] → [Directory structure].

Selecting [Camera] automatically creates a folder structure matching that of the camera's (such as A/DCIM/100EOS1D) in the server's root folder for image storage. If you have created a subfolder in the root folder by changing the [Target folder] setting, a folder structure such as A/DCIM/100EOS1D is automatically created in that folder for image storage.

Selecting [Default] will use the root folder for image storage. If you have created a subfolder in the root folder by changing the [Target folder] setting, images are saved in that folder.

Overwriting Files of the Same Name

Configured in [FTP server] → [Overwrite same file].

When the transmitter is configured to prevent overwriting

If there is already a file of the same name in the target folder on the FTP server, the new file is saved with an extension consisting of an underline and a number, as in IMG_0003_1.JPG.

When you resend images if initial transfer fails

Even if the transmitter is configured to overwrite files of the same name, if you resend an image file that could not be transferred initially, the existing file may not be overwritten in some cases. If this happens, the new file is saved with an extension consisting of an underline, a letter, and a number, as in IMG_0003_a1.JPG.

Passive Mode

Configured in [FTP server] → [Passive mode].

Enable this setting in network environments protected by a firewall. If an Error 41 occurs ("Cannot connect to FTP server"), setting passive mode to [Enable] may enable access to the FTP server.

Preventing Changes to Settings

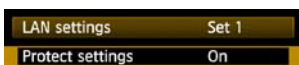

To prevent accidental changes to LAN settings, set [Protect settings] to [On].

Saving and Loading Settings

Network settings can be saved on a memory card for use with other cameras.

Saving Settings



1 In [WFT settings], select [Set up].

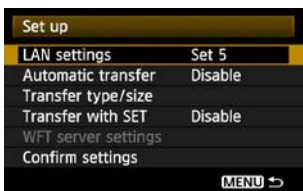

2 Select [LAN settings].

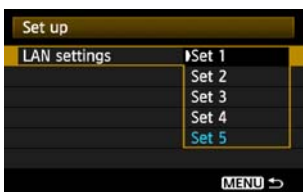

3 Select the settings number.

- Here, select the settings number that identifies the LAN settings.



4 Select [Change].

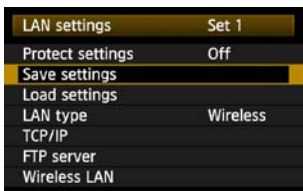

5 Select [Save settings].

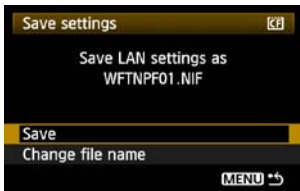

6

Select [Save].

- ▶ The settings are now saved as a file on the memory card.
- The settings are saved as a file (WFTNPF**.NIF) in the area of the memory card shown when the card is opened (in the root directory).
- The file name is determined automatically by the camera: WFTNPF, followed by a number (01 to 99) and the extension NIF. You can rename the file as desired by selecting [Change file name].

Loading Settings

Load settings files stored on a memory card as follows. Also use this procedure when loading settings files created on a computer.

Make sure the settings file is saved in the folder shown when the memory card is opened (that is, the root directory).

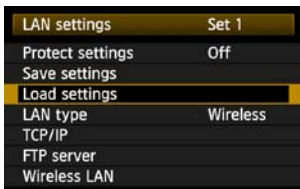

1

Select [Load settings].



2

Select the settings file.

- ▶ Select a settings file that matches your network environment.



3

Load the settings file.

- ▶ Information from the settings file is loaded into the selected settings number.

7

Using External Media

Commercially available external media, connected via USB, can be used the same way as CF and SD cards. You can also back up images from CF and SD cards onto external media.

Note that external media must meet the following requirements.

- Use media conforming to the USB Mass Storage Class Specification.
- If an external hard disk drive is used, use a self-powered drive. Bus-powered drives do not work in some situations.
- The main image storage area must be formatted with a FAT16 or FAT32 file system.
- Use media with a main image storage area of less than 1 TB (terabyte), with 512 bytes per sector.
- Do not use external media equipped with a card slot.

Connecting External Media

Before connecting external media to the transmitter, switch the camera's power switch to <OFF>. Also turn off external media that has its own power supply.

When connecting external media, be sure to use the USB cable provided with the camera.

The transmitter USB port is not hot-pluggable. USB cables cannot be connected or disconnected at any time. Follow the instructions in this section when connecting or disconnecting USB cables.

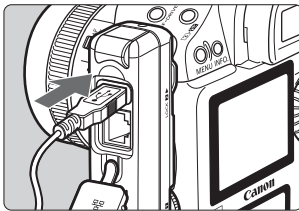

1 Plug the external media into the USB port.

- Open the port cover and connect the external media.
- Do not connect external media via a USB hub.
- If the external media is self-powered, turn it on after connecting it.

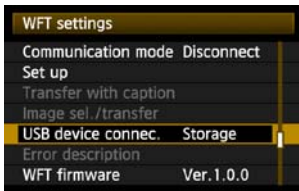

2 In [WFT settings], select [USB device connec.].

- If you will not use a wireless or wired LAN at the same time as the external media, set [Communication mode] to [Disconnect].

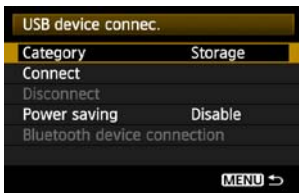

3 Select [Storage].

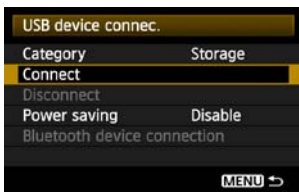
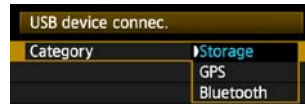

4 Select [Connect].

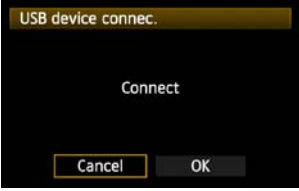

5 Select [OK].

- Camera operations such as shooting, menu display, or image playback are not possible until the connection is established.
- When the transmitter is connected to the external media, the transmitter's <USB> lamp is lit in green and a message is displayed indicating that a connection has been established.
- When the confirmation message is displayed, select [OK].



- ▶ At this point, the menu option [Disconnect] becomes available. Select this option before disconnecting the external media.

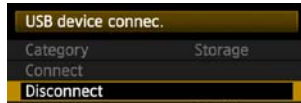

- ▶ After you exit the menu, the rear LCD panel indicates that external media is connected.

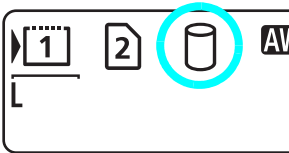

 External media cannot be formatted using the camera. Format it with a FAT16 or FAT32 file system using the computer.

Unplugging External Media from the USB Port

Before unplugging external media from the USB port, always select **[Disconnect]** as shown in step 5. Follow the instructions displayed to terminate the connection.

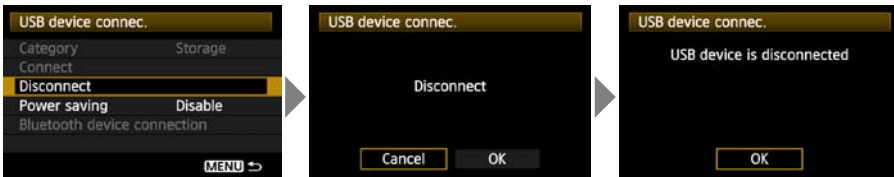

The connection will not be terminated if you simply turn off the camera and external media. If you unplug external media while the connection is still active, plug the external media into the USB port again and follow the preceding steps to terminate the connection.

Power Supply to External Media

External media is powered via the transmitter's USB port as needed. However, external hard disk drives may not work after connection in some cases.

Power Management



- If you will not use a wireless or wired LAN at the same time as the external media, set **[Communication mode]** to **[Disconnect]**. The camera battery drains faster under settings other than **[Disconnect]** because power saving is disabled.
- Setting **[Power saving]** to **[Enable]** enables the power supply to external media to be stopped automatically, conserving the camera battery. Power is supplied again automatically during shooting, when captured images are stored.

Before shooting movie, set **[Power saving]** to **[Disable]** and make sure the transmitter's <USB> lamp is lit in green. If you start shooting movie when the <USB> lamp is out or blinking, the movie may not be recorded to external media.

Choosing Recording Media When Shooting

Images can be stored on external media connected via USB just as on CF and SD cards. You can also configure **[Record func.]**, **[Record/play]**, and **[Folder]** settings (described below) to use the external media. For details, refer to the Camera Instruction Manual (page 56). When recording movies to a hard disk, use a hard disk with fast write speeds.



On the **[P]** tab, select **[Record func+media/folder sel.]**.

- ▶ The icon for external media is displayed next to icons for the CF and SD cards.

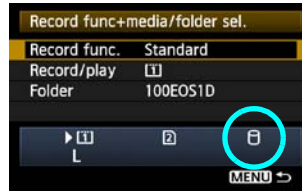

- Complete the following settings, as needed. For details on using **[Record/play]** with external media, refer to the next page.



Although the **<USB>** lamp will blink in green briefly if the camera is restarted or recovering from auto power off, shooting is still possible. Any images captured at this time are stored temporarily in the camera's internal memory and then recorded on external media when the **<USB>** lamp remains lit in green.

[Record/play] Setting

When you select external media in **[Record/play]**, the **[Select location for DCIM folder]** screen is displayed. The DCIM folder contains the EOS1D folder, where images are stored.



- To create the DCIM folder in the first folder displayed when the external media is opened (that is, the root directory), select the default setting of **[/]**.

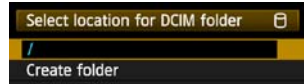

- To create another parent folder for the DCIM folder, select **[Create folder]**. A screen is displayed for entering the folder name.
- By default, the folder name comprises the current date (last two digits of the year, in addition to the month and day) and numbers representing the order the folder was created, in a range of 01 to 99.
- Always use 8 characters for the folder name.

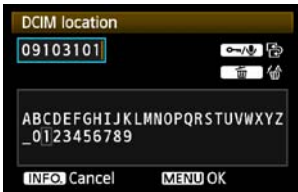

For instructions on entering the folder name, refer to “Virtual Keyboard Operation” (p.27).

Copying Images

Images can be copied to external media connected via USB just as to CF and SD cards.



1 On the [**Ⓜ**] tab, select [**Record func+media/folder sel.**].

- ▶ The icon for external media is displayed next to icons for the CF and SD cards.



2 Select the source media in [**Record/play**].

- After selection, press the <MENU> button to return to the menu screen.



3 On the [**Ⓜ**] tab, select [**Image copy**].

- For subsequent instructions, refer to the Camera Instruction Manual (page 176). Operations are the same as when using a CF or SD card, except that the external media icon <Ⓜ> is displayed.



Backing Up on External Media

Images stored on CF or SD cards can be backed up on external media.

Initially, captured images are stored in the DCIM folder on CF or SD cards. Selecting **[External media backup]** backs up this DCIM folder to external media.



1 On the **[P]** tab, select **[External media backup]**.

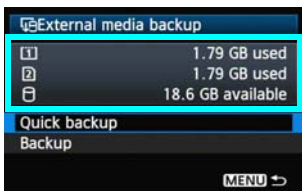

2 Check the free space on the media.

- Make sure more space is available on the external media than the amount used on the memory card. If less free space is available on the external media, backup is not possible.

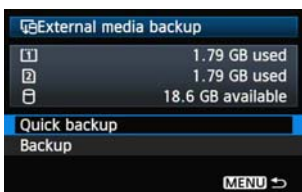

3 Select the method of backup.

- Select **[Quick backup]** or **[Backup]**.



- You can also backup the MISC folder, where printing and transfer instructions are stored.
- External media cannot be backed up onto memory cards.
- If the backup destination already has a folder of the same number containing images of the same number, **[Skip image and continue]**, **[Replace existing image]**, and **[Cancel backup]** are displayed. Select the backup method and press **<SET>**.
 - **[Skip image and continue]**: All images are backed up except for images of the same number as existing images
 - **[Replace existing image]**: All images are backed up, including images of the same number as existing images
- Shooting is not possible during backup. Press **[Cancel]** before shooting.

Quick Backup

A simple method of backup is available, as follows.

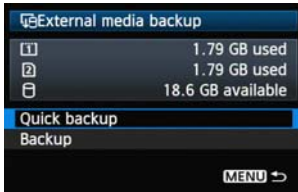

1 Select [Quick backup].



2 Select the source memory card.

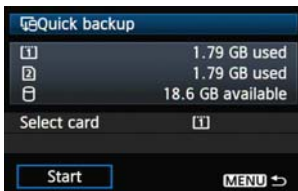

3 Select [Start].

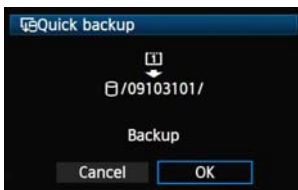

4 Select [OK].

▶ The backup process now begins.

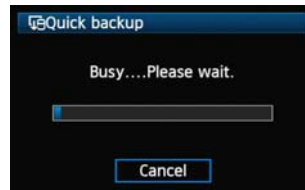

- When the message indicating completion is displayed, select [OK].

Where the DCIM Folder is Stored

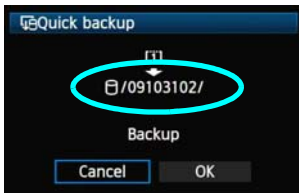

- The DCIM folder is stored in a directory indicated by a file path such as [/09103102].
- The target folder name comprises the current date (last two digits of the year, in addition to the month and day) and numbers representing the order the folder was created, in a range of 01 to 99.
- In the example shown at left, the folder displayed when the external media is opened (that is, the root directory) is named 09103102. The DCIM folder is stored in this folder.
- This is also the target folder name displayed when using the regular [Backup] option.

Backup

Select regular [Backup] to create or use a folder of your choice as the parent folder of the DCIM folder. You can also name this folder as desired. Other functions in this method of backup are the same as for [Quick backup].



1 Select [Backup].



2 Select the source memory card.



3 Select [DCIM location].

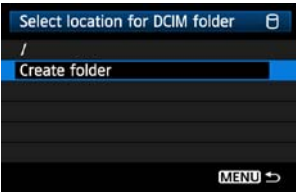

4 Select [Create folder].

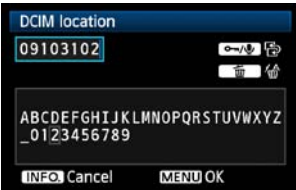

5 Enter the [Folder name].

- Always use 8 characters for the folder name.
- For instructions on entering the folder name, refer to “Virtual Keyboard Operation” (p.27).



6 Select [Start].

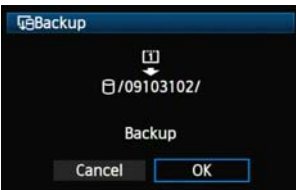

7 Select [OK].

- ▶ The backup process now begins.

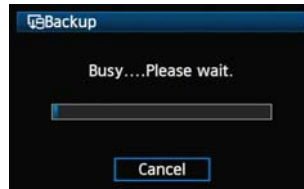

When the message indicating completion is displayed, select [OK].

External Media Case

The provided external media case can hold portable hard disks up to 120 x 75 x 15 mm/
4.72 x 2.95 x 0.59 in.

8

Using GPS Devices

Commercially available GPS devices connected via USB can obtain information including the latitude, longitude, altitude, and date and time of shooting and add it to images. The additional information can be checked on the camera as well as by using GPS-compatible mapping software.

The transmitter can be used with Garmin GPSMAP or eTrex series or Magellan eXplorist series GPS devices that produce data in the format NMEA 0183 Ver. 3.0.1, as well as some devices that produce Garmin protocol data (as of November 2009).

For a list of specific GPS devices supported, contact the Canon Service Center.

For GPS device instructions, refer to the device's instruction manual or contact the manufacturer.

Connecting GPS Devices with a USB Cable

Turn off the GPS device and camera before connecting them.

When connecting GPS devices, be sure to use the USB cable provided with the camera.

The transmitter USB port is not hot-pluggable. USB cables cannot be connected or disconnected at any time. Follow the instructions in this section when connecting or disconnecting USB cables.

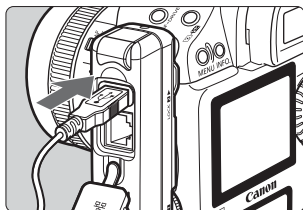

1 Plug the GPS device into the USB port.

- Open the port cover and connect the GPS device.
- Do not connect GPS device via a USB hub.
- Do not turn the GPS device on until step 5.



2 In [WFT settings], select [USB device connec.].

- If you will not use a wireless or wired LAN at the same time as the GPS device, set [Communication mode] to [Disconnect].



3 Select [GPS].

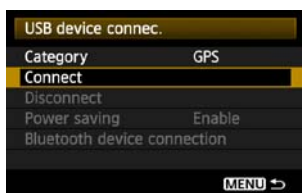

4 Select [Connect].



5 Select [OK].

- After selecting [OK], turn the GPS device on.
- It may take a few minutes to establish a connection with the GPS device. **Camera operations such as shooting, menu display, or image playback are not possible until the connection is established.**
- When the transmitter is connected to the GPS device, the transmitter's <USB> lamp is lit in green and a message is displayed indicating that a connection has been established.
- When the confirmation message is displayed, select [OK].



- At this point, the menu option [Disconnect] becomes available. Select this option before disconnecting the GPS device.

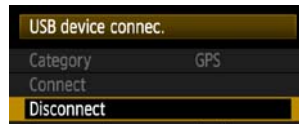

6 Take the picture.

- Make sure the transmitter's <USB> lamp is lit in green before shooting.
- **If the <USB> lamp is not lit in green when you shoot, correct GPS data will not be added to images.**

7 Check the GPS data.

- View an image.
- Press the <INFO.> button to display the shooting information screen with GPS data.

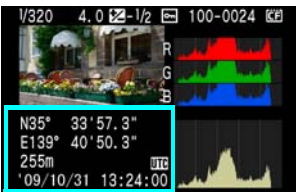

From top to bottom: latitude, longitude, altitude, and Coordinated Universal Time



If the camera is turned off and on or recovering from auto power off, do not shoot until the <USB> lamp remains lit in green. If you shoot while the lamp is blinking, the correct GPS information may not be added to images.



The date and time indicated is the Coordinated Universal Time (UTC) as obtained by the GPS device, which is nearly the same as Greenwich Mean Time (GMT). In some cases, the date and time of the zone specified on the GPS device is indicated.

Unplugging GPS Devices from the USB Port

Before unplugging GPS devices from the USB port, always select **[Disconnect]** as shown in step 5. Follow the instructions displayed to terminate the connection.

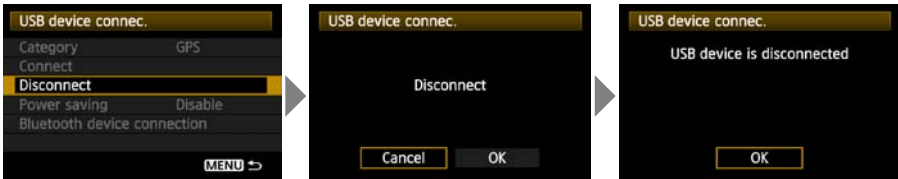

The connection will not be terminated if you simply turn off the camera and GPS device. If you unplug GPS device while the connection is still active, plug the GPS device into the USB port again and follow the preceding steps to terminate the connection.

Power Management

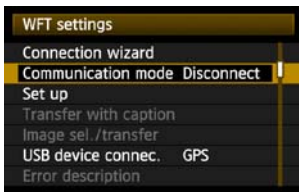

- If you will not use a wireless or wired LAN at the same time as the GPS device, set **[Communication mode]** to **[Disconnect]**. The camera battery drains faster under settings other than **[Disconnect]** because power saving is disabled.

Connecting GPS Devices via Bluetooth

By attaching the Canon Bluetooth Unit BU-30 to the USB port, you can connect Bluetooth® GPS devices wirelessly. (Bluetooth® devices other than GPS devices cannot be connected). When using non-Canon Bluetooth units, confirm normal operation before use.

Turn off the GPS device and camera before attaching the Bluetooth unit to the transmitter.

The transmitter's USB port is not hot-pluggable. Bluetooth units cannot be connected or disconnected indiscriminately. Follow the instructions in this section when attaching or detaching Bluetooth units.

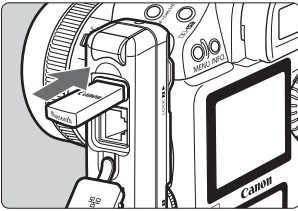

1 Attach the Bluetooth unit.

- Open the port cover and attach the Bluetooth unit.



2 In [WFT settings], select [USB device connec.]

- If you will not use a wireless or wired LAN at the same time as the Bluetooth unit, set [Communication mode] to [Disconnect].



3 Select [Bluetooth].

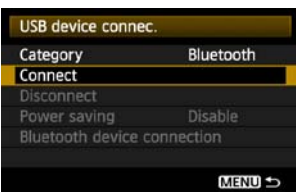

4 Select [Connect].



5 Select [OK].

- After the Bluetooth unit is attached to the transmitter, the transmitter's <USB> lamp blinks in green and a message is displayed indicating that a connection has been established.
- When the confirmation message is displayed, select [OK].



- ▶ At this point, the menu option [Disconnect] becomes available. Select this option before detaching the GPS device.

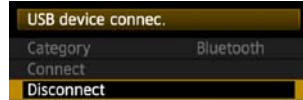

6 Establish a wireless connection between the GPS device and Bluetooth unit.

- Turn on the GPS device and activate Bluetooth® on it.
- Select [Bluetooth device connection].
- ▶ Nearby Bluetooth® devices in use are listed. (Only GPS devices can be connected.)

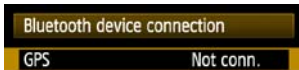

7 Select the GPS device.

- Press <SET> to display the connection status of Bluetooth® devices.
- Pressing <SET> when the status is [Not conn.] will list nearby Bluetooth® devices in use.
- Turn the <DIS> dial to select [GPS], and then press <SET>.
- Select [OK] and press <SET>.
- If a Bluetooth® password has been set on the GPS device, a password input screen is displayed. Enter the password.
- ▶ The transmitter now starts to establish a connection with the GPS device.
- It may take a few minutes to establish a connection with the GPS device.

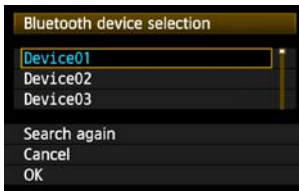

Camera operations such as shooting, menu display, or image playback are not possible until the connection is established.



8 When the confirmation message is displayed, select [OK].

- The GPS connection status changes to [Connecting]. Pressing <SET> under these conditions will enable you to disconnect the GPS device.

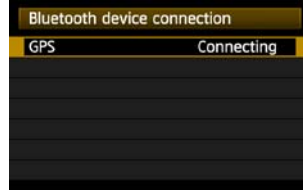

9 Take the picture.

- Make sure the transmitter's <USB> lamp is lit in green before shooting.
- If the <USB> lamp is not lit in green when you shoot, the correct GPS data will not be added to images.



10 Check the GPS data.

- View an image.
- Press the <INFO.> button to display the shooting information screen with GPS data.

From top to bottom: latitude, longitude, altitude, and Coordinated Universal Time



If the camera is turned off and on or recovering from auto power off, do not shoot until the <USB> lamp remains lit in green. If you shoot while the lamp is blinking, the correct GPS information may not be added to images.



The date and time indicated is the Coordinated Universal Time (UTC) as obtained by the GPS device, which is nearly the same as Greenwich Mean Time (GMT). In some cases, the date and time of the zone specified on the GPS device is indicated.

🔌 Detaching Bluetooth units from the USB port

Before detaching Bluetooth units from the USB port, always select **[Disconnect]** as shown in step 5. Follow the instructions displayed to terminate the connection.

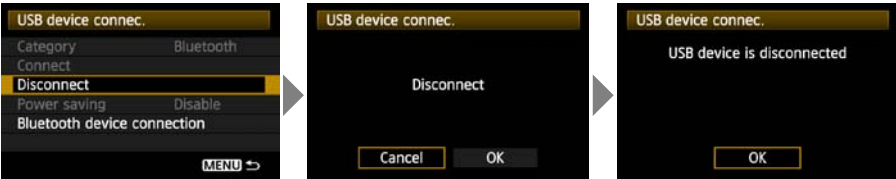

The connection with the Bluetooth unit will not be terminated if you simply turn off the camera. If you detach a Bluetooth unit while the connection is still active, attach the Bluetooth unit again and follow the preceding steps to terminate the connection.

Power Management

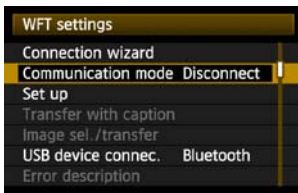

- If you will not use a wireless or wired LAN at the same time as the Bluetooth unit, set **[Communication mode]** to **[Disconnect]**. The camera battery drains faster under settings other than **[Disconnect]** because power saving is disabled.

9

Troubleshooting

Responding to Error Messages

If transmitter errors are displayed on the camera LCD monitor, refer to the examples of corrective actions in this section to eliminate the cause of the error. The error details can also be checked on the [🔍] tab [WFT settings] → [Error description].

Click the error number in the following chart to jump to the corresponding page.

11 (p.93)	12 (p.93)			
21 (p.93)	22 (p.94)	23 (p.94)	24 (p.95)	25 (p.96)
26 (p.96)				
31 (p.97)	32 (p.97)	33 (p.97)	34 (p.97)	
41 (p.98)	42 (p.99)	43 (p.99)	44 (p.99)	45 (p.100)
46 (p.100)	47 (p.101)			
51 (p.101)	52 (p.101)	53 (p.101)	54 (p.101)	
61 (p.102)	62 (p.102)	63 (p.103)	64 (p.103)	65 (p.103)
66 (p.104)	67 (p.104)	68 (p.104)	69 (p.104)	
71 (p.105)	72 (p.105)			
81 (p.105)				
99 (p.105)				

11: Connection target not found

- **Is the pairing software running?**
 - ▶ Start the pairing software and follow the instructions to re-establish the connection. (p.44)
- **Are the transmitter and wireless LAN terminal configured with the same encryption key for authentication?**
 - ▶ This error occurs if the encryption keys do not match when the authentication method for encryption is **[Open system]**.
The setting is case-sensitive, so check upper- and lower-case characters. Make sure the correct encryption key for authentication is entered on the transmitter. (p.22)

12: Connection target not found

- **Are the target computer and wireless LAN terminal on?**
 - ▶ Turn on the target computer and wireless LAN terminal.

21: No address assigned by DHCP server

What to check on the transmitter

- **On the transmitter, the network setting is [Auto setting] or the IP address setting is [Auto assign]. Does the error occur under these settings?**
 - ▶ If no DHCP server is used, set the transmitter's network setting to **[Manual setting]** and IP address setting to **[Manual setting]**. (p.25)

What to check on the DHCP server

- **Is the DHCP server on?**
 - ▶ Turn the DHCP server on.
- **Are there enough addresses for assignment by the DHCP server?**
 - ▶ Increase the number of addresses assigned by the DHCP server.
 - ▶ Remove devices assigned addresses by the DHCP server from the network to reduce the number of addresses in use.
- **Is the DHCP server working correctly?**
 - ▶ Check the DHCP server settings to make sure it is working correctly as a DHCP server.
 - ▶ If applicable, ask your network administrator to ensure the DHCP server is available.



Responding to Error Messages 21 - 26

Also check the following points when responding to errors numbered 21 - 26.

Are the transmitter and wireless LAN terminal configured with the same encryption key for authentication?

- ▶ This error occurs if the encryption keys do not match when the authentication method for encryption is **[Open system]**. The setting is case-sensitive, so check upper- and lower-case characters. Make sure the correct encryption key for authentication is entered on the transmitter. (p.22)

22: No response from DNS server

What to check on the transmitter

- **On the transmitter, the DNS address setting is [Auto assign] or [Manual setting]. Does the error occur under these settings?**
 - ▶ If no DNS server is used, set the transmitter's DNS address setting to [Disable]. (p.25)
- **On the transmitter, does the DNS server's IP address setting match the server's actual address?**
 - ▶ Configure the IP address on the transmitter to match the actual DNS server address. (p.25, 107)

What to check on the DNS server

- **Is the DNS server on?**
 - ▶ Turn the DNS server on.
- **Are the DNS server settings for IP addresses and the corresponding names correct?**
 - ▶ On the DNS server, make sure IP addresses and the corresponding names are entered correctly.
- **Is the DNS server working correctly?**
 - ▶ Check the DNS server settings to make sure the server is working correctly as a DNS server.
 - ▶ If applicable, ask your network administrator to ensure the DNS server is available.

What to check on the network as a whole

- **Does your network include a router or similar device that serves as a gateway?**
 - ▶ If applicable, ask your network administrator for the network gateway address and enter it on the transmitter. (p.25, 107)
 - ▶ Make sure the gateway address setting is correctly entered on all network devices, including the transmitter.

23: Duplicate IP address

What to check on the transmitter

- **Is another device on the transmitter network using the same IP address as the transmitter?**
 - ▶ Change the transmitter's IP address to avoid using the same address as another device on the network. Otherwise, change the IP address of the device that has a duplicate address.
 - ▶ In network environments with a DHCP server, if the transmitter's IP address setting is [Manual setting], change it to [Auto assign]. (p.25)

24: No response from proxy server

What to check on the transmitter

- **The transmitter's proxy server setting is [Enable]. Does the error occur under this setting?**
 - ▶ If no proxy server is used, set the transmitter's proxy server setting to [**Disable**]. (p.30)
- **Do the transmitter's [Address setting] and [Port No.] settings match those of the proxy server?**
 - ▶ Configure the transmitter's proxy server address and port number to match those of the proxy server. (p.30)
- **In the transmitter's [Proxy server] settings, have you only entered [Server name]?**
 - ▶ If the proxy server's [**Address**] setting is not configured on the transmitter, enter it along with the DNS server address. (p.25) Make sure the server name and port number for the proxy server are entered correctly. (p.30)

What to check on the proxy server

- **Is the proxy server on?**
 - ▶ Turn the proxy server on.
- **Is the proxy server working correctly?**
 - ▶ Check the proxy server settings to make sure the server is working correctly as a proxy server.
 - ▶ If applicable, ask your network administrator for the proxy server address or server name and port number, and then enter them on the transmitter.

What to check on the network as a whole

- **Does your network include a router or similar device that serves as a gateway?**
 - ▶ If applicable, ask your network administrator for the network gateway address and enter it on the transmitter.
 - ▶ Make sure the gateway address setting is correctly entered on all network devices, including the transmitter.

25: Another terminal has set the same IP address

- **Is another device on the transmitter network using the same IP address as the transmitter?**
- ▶ This error occurs if the transmitter is connected to a network where another device subsequently connects with the same IP address. Change the transmitter's IP address to avoid using the same address as another device on the network. Otherwise, change the IP address of the device that has a duplicate address.

26: No response from DHCP server

What to check on the transmitter

- **On the transmitter, the network setting is [Auto setting]. Does the error occur under this setting?**
- ▶ If no DHCP server is used, set the transmitter's network setting to [Manual setting]. (p.25)

What to check on the DHCP server

- **Is the DHCP server on?**
- ▶ Turn the DHCP server on.
- **Are the DHCP server settings for IP addresses and the corresponding names correct?**
- ▶ On the DHCP server, make sure IP addresses and the corresponding names are entered correctly.
- **Is the DHCP server working correctly?**
- ▶ Check the DHCP server settings to make sure it is working correctly as a DHCP server.
- ▶ If applicable, ask your network administrator to ensure the DHCP server is available.

What to check on the network as a whole

- **Does your network include a router or similar device that serves as a gateway?**
- ▶ If applicable, ask your network administrator for the network gateway address and enter it on the transmitter. (p.25)
- ▶ Make sure the gateway address setting is correctly entered on all network devices, including the transmitter.

31: USB connection disconnected

- **Has the USB cable been disconnected?**
 - ▶ After connecting the USB cable, in **[WFT settings]**, select **[USB device connec.]** and reconnect the device.
- **Is the USB device on?**
 - ▶ Turn the USB device on. Next, also in **[WFT settings]**, select **[USB device connec.]** and reconnect the device.

32: Incompatible USB device

- **Have you connected a USB device other than external media, a GPS device, or a Bluetooth unit?**
 - ▶ Connect only external media, GPS devices, or Bluetooth units.
- **The device is incompatible with the transmitter.**
 - ▶ External media with built-in card slots are not compatible. Similarly, USB card readers cannot be used.
- **Is the external media formatted with a FAT16 or FAT32 file system?**
 - ▶ Format the external media with a FAT16 or FAT32 file system using the computer.
- **The GPS device is incompatible with the transmitter.**
 - ▶ Among GPS devices, we recommend devices for which operation has been verified by Canon.

33: USB device error

- **There is a problem with the external media.**
 - ▶ Connect the external media to a computer and confirm that it is working correctly.

34: Cannot connect to USB device

- **Have you connected a USB device other than external media, a GPS device, or a Bluetooth unit?**
 - ▶ Connect only external media, GPS devices, or Bluetooth units.

41: Cannot connect to FTP server

What to check on the transmitter

- **On the transmitter, does the FTP server's IP address setting match the server's actual address?**
 - ▶ Configure the IP address on the transmitter to match the actual FTP server address. (p.30)
- **Are the transmitter and wireless LAN terminal configured with the same encryption key for authentication?**
 - ▶ This error occurs if the encryption keys do not match when the authentication method for encryption is **[Open system]**.
The setting is case-sensitive, so check upper- and lower-case characters. Make sure the correct encryption key for authentication is entered on the transmitter. (p.22)
- **On the transmitter, does the [Port number setting] for the FTP server match the actual port number of the FTP server?**
 - ▶ Configure the same port number (usually 21) on the transmitter and FTP server. Configure the port number on the transmitter to match the actual FTP server port number. (p.30)
- **If only the FTP server's [Server name] is configured on the transmitter, are the DNS server settings complete?**
 - ▶ If the FTP server's **[Address]** setting is not configured on the transmitter, enable use of the DNS server on the transmitter and enter its address. (p.25) Make sure the FTP server name is entered correctly. (p.30)

What to check on the FTP server

- **Is the FTP server working correctly?**
 - ▶ Configure the computer correctly to function as an FTP server.
 - ▶ If applicable, ask your network administrator for the FTP server address and port number, and then enter them on the transmitter.
- **Is the FTP server on?**
 - ▶ Turn the FTP server on. The server may have been turned off because of an energy-saving mode.
- **On the transmitter, does the FTP server's IP address setting (in [Address]) match the server's actual address?**
 - ▶ Configure the IP address on the transmitter to match the actual FTP server address. (p.30)
- **Is a firewall or other security software enabled?**
 - ▶ Some security software uses a firewall to restrict access to the FTP server. Change the firewall settings to allow access to the FTP server.
 - ▶ You may be able to access the FTP server by setting **[Passive mode]** to **[Enable]** on the transmitter. (p.68)

- **Are you connecting to the FTP server via a broadband router?**
 - ▶ Some broadband routers use a firewall to restrict access to the FTP server. Change the firewall settings to allow access to the FTP server.
 - ▶ You may be able to access the FTP server by setting [**Passive mode**] to [**Enable**] on the transmitter. (p.68)
- **If you are using Windows XP Service Pack 2 or later, is access to the FTP server blocked by [Windows Firewall]?**
 - ▶ Change the Windows Firewall settings to allow access to the FTP server.

What to check on the network as a whole

- **Does your network include a router or similar device that serves as a gateway?**
 - ▶ If applicable, ask your network administrator for the network gateway address and enter it on the transmitter. (p.25)
 - ▶ Make sure the gateway address setting is correctly entered on all network devices, including the transmitter.

42: FTP server rejected connection

What to check on the FTP server

- **Is the FTP server configured to restrict access to only some IP addresses?**
 - ▶ Change the FTP server settings to allow access from the [**IP address**] configured on the transmitter in the TCP/IP settings.

43: Cannot connect to FTP server. Error code received from server.

What to check on the FTP server

- **Have you exceeded the maximum number of FTP server connections?**
 - ▶ Disconnect some network devices from the FTP server or increase the maximum number of connections.

44: Cannot disconnect FTP server. Error code received from server.

- **This error occurs if the transmitter fails to disconnect from the FTP server for some reason.**
 - ▶ Restart the FTP server and camera.

45: Cannot login to FTP server. Error code received from server.

What to check on the transmitter

- **On the transmitter, is the [Login name] entered correctly?**
 - ▶ Check the logon name for accessing the FTP server. The setting is case-sensitive, so check upper- and lower-case characters. Make sure the correct logon name is entered on the transmitter. (p.31)
- **On the transmitter, is the [Login password] entered correctly?**
 - ▶ If a logon password is configured on the FTP server, check the upper- and lower-case characters to make sure the password on the transmitter matches it. (p.31)

What to check on the FTP server

- **Do the user rights for the FTP server allow reading, writing, and log access?**
 - ▶ Configure the FTP server's user rights to allow reading, writing, and log access.
- **Is the folder specified as the transfer destination on the FTP server named with ASCII characters (p.27)?**
 - ▶ Use ASCII characters for the folder name.

46: For the data session, error code received from FTP server

What to check on the FTP server

- **The connection was terminated by the FTP server.**
 - ▶ Restart the FTP server.
- **Do the user rights for the FTP server allow reading, writing, and log access?**
 - ▶ Configure the FTP server's user rights to allow reading, writing, and log access.
- **Do user rights allow access to the target folder on the FTP server?**
 - ▶ Configure the user rights for access to the target folder on the FTP server to allow saving images from the transmitter.
- **Is the FTP server on?**
 - ▶ Turn the FTP server on. The server may have been turned off because of an energy-saving mode.
- **Is the hard disk of the FTP server full?**
 - ▶ Increase available space on the hard disk.

47: Image file transfer completion not confirmed by FTP server

- **This error occurs if, for some reason, the transmitter fails to receive confirmation from the FTP server that image file transfer is complete.**
- ▶ Restart the FTP server and camera and send the images again.

51: Connection with Bluetooth unit lost

- **Is the Bluetooth unit too far from the GPS device?**
- ▶ Bring the GPS device closer to the Bluetooth unit.
- **Are any obstacles blocking the line of sight between the Bluetooth unit and the GPS device?**
- ▶ Move the GPS device to a position visible from the point of view of the Bluetooth unit.
- **The Bluetooth unit and GPS device were disconnected, for some reason, and the connection cannot be restored.**
- ▶ The connection is more likely to be lost if there are nearby wireless LAN terminals, cordless telephones, microphones, microwave ovens, or similar devices operating on the same 2.4 GHz band used for Bluetooth communication. Also note that the connection is more likely to be lost in poor weather or high humidity.
- **Is the GPS device on?**
- ▶ Turn the GPS device on.

52: Bluetooth unit not found

- **Is the GPS device ready for the Bluetooth connection?**
- ▶ Turn the GPS device on and set it up for connection via Bluetooth.
- **Is the Bluetooth unit too far from the GPS device?**
- ▶ Bring the GPS device closer to the Bluetooth unit.
- **Is the GPS device on?**
- ▶ Turn the GPS device on.

53: Incorrect Bluetooth password

- **Is the same password set on the Bluetooth unit and GPS device?**
- ▶ The setting is case-sensitive, so check upper- and lower-case characters. Make sure the correct password is entered on the GPS device and Bluetooth unit.

54: No Bluetooth service

- **The GPS device does not support SPP (Serial Port Profile).**
- ▶ Confirm that the GPS device supports SPP.

61: Same SSID wireless LAN terminal not found

- **Are any obstacles blocking the line of sight between the transmitter and the antenna of the wireless LAN terminal?**
- ▶ Move the antenna to a position clearly visible from the point of view of the transmitter. (p.106)

What to check on the transmitter

- **On the transmitter, does the SSID setting match that of the wireless LAN terminal?**
- ▶ Check the SSID on the wireless LAN terminal, and configure the same SSID on the transmitter. (p.21)

What to check on the wireless LAN terminal

- **Is the wireless LAN terminal on?**
- ▶ Turn on the wireless LAN terminal.
- **When you are using WFT-E2 IID with wireless LAN terminals supporting IEEE 802.11a, are the terminal settings locked on IEEE 802.11a?**
- ▶ Configure the wireless LAN terminal to allow access via IEEE 802.11b and g.
- **If you are filtering by MAC address, did you register the transmitter's MAC address on the wireless LAN terminal?**
- ▶ Register the transmitter's MAC address (p.66) on the wireless LAN terminal.

62: No response from wireless LAN terminal

What to check on the transmitter

- **Is the transmitter configured for communication in infrastructure mode?**
- ▶ Configure the transmitter for communication in ad hoc mode.

What to check on the wireless LAN terminal

- **Is there a nearby wireless LAN terminal for ad hoc communication?**
- ▶ Prepare a wireless LAN terminal for ad hoc communication near the transmitter.

63: Wireless LAN authentication failed

- **Are the transmitter and wireless LAN terminal configured for the same authentication method?**
 - ▶ The transmitter supports these authentication methods: [Open system], [Shared key], [WPA-PSK], and [WPA2-PSK]. (p.21)
 - ▶ When using an AirPort for communication in infrastructure mode, [Open system] is not supported. Configure a [Shared key] on the transmitter. (p.21)
- **Are the transmitter and wireless LAN terminal configured with the same encryption key for authentication?**
 - ▶ The setting is case-sensitive, so check upper- and lower-case characters. Make sure the correct encryption key for authentication is entered on the transmitter and wireless LAN terminal. (p.22)
- **If you are filtering by MAC address, did you register the transmitter's MAC address on the wireless LAN terminal?**
 - ▶ Register the transmitter's MAC address (p.66) on the wireless LAN terminal.

64: Cannot connect to wireless LAN terminal

- **Are the transmitter and wireless LAN terminal configured for the same encryption method?**
 - ▶ The transmitter supports these encryption methods: [WEP], [TKIP], and [AES]. (p.21)
- **If you are filtering by MAC address, did you register the transmitter's MAC address on the wireless LAN terminal?**
 - ▶ Register the transmitter's MAC address (p.66) on the wireless LAN terminal.

65: Wireless LAN connection lost

- **Are any obstacles blocking the line of sight between the transmitter and the antenna of the wireless LAN terminal?**
 - ▶ Move the antenna to a position clearly visible from the point of view of the transmitter. (p.106)
- **The wireless LAN connection was lost, for some reason, and the connection cannot be restored.**
 - ▶ The following are possible reasons: excessive access to the wireless LAN terminal from other terminals, a microwave oven or similar appliance in use nearby (interfering with IEEE 802.11b/g reception), poor weather and high humidity. (p.106)

66: Incorrect wireless LAN encryption key

- **Are the transmitter and wireless LAN terminal configured with the same encryption key for authentication?**
 - ▶ The setting is case-sensitive, so check upper- and lower-case characters. Make sure the correct encryption key for authentication is entered on the transmitter and wireless LAN terminal. (p.22)
Note that if the authentication method is **[Open system]**, an Error 41 (“Cannot connect to FTP server”) is displayed.

67: Incorrect wireless LAN encryption method

- **Are the transmitter and wireless LAN terminal configured for the same encryption method?**
 - ▶ The transmitter supports these encryption methods: **[WEP]**, **[TKIP]**, and **[AES]**. (p.21)
- **If you are filtering by MAC address, did you register the transmitter’s MAC address on the wireless LAN terminal?**
 - ▶ Register the transmitter’s MAC address (p.66) on the wireless LAN terminal.

68: Cannot connect to wireless LAN terminal. Retry from the beginning.

- **Have you pressed the Wi-Fi Protected Setup (WPS) button on the wireless LAN terminal for as long as indicated in the wireless LAN terminal instructions?**
 - ▶ Refer to the instruction manual for the wireless LAN terminal to determine how long to hold the WPS button.
- **Are you attempting to establish the connection near the wireless LAN terminal?**
 - ▶ Try establishing the connection when both devices are within reach of each other.

69: Multiple wireless LAN terminals have been found. Cannot connect. Retry from the beginning.

- **Connection is in progress by other wireless LAN terminals in Pushbutton Connection mode (PBC mode) of Wi-Fi Protected Setup (WPS).**
 - ▶ Wait a while before trying to establish the connection, or try to establish a connection in PIN code connection mode (PIN mode). (p.24)

71: Cannot connect to slave cameras

- **Are you following the correct procedure to establish the connection with slave cameras?**
 - ▶ Operate slave cameras by following the correct instructions (p.62, 63).
- **Are the slave cameras too far from the master camera?**
 - ▶ Bring the slave cameras closer to the master camera.

72: Cannot connect to the master camera

- **Are you following the correct procedure to establish the connection with master camera?**
 - ▶ Operate the master camera by following the correct instructions (p.62, 63).
- **Is the master camera too far from the slave cameras?**
 - ▶ Bring the master camera closer to the slave cameras.

81: Wired LAN connection lost

- **Is the LAN cable securely connected?**
 - ▶ Reconnect the LAN cable between the transmitter and server. Because the cable may be severed, try using another cable to connect the devices.
- **Is the hub or router on?**
 - ▶ Turn on the hub or router.
- **Is the server on?**
 - ▶ Turn the server on. The server may have been turned off because of an energy-saving mode.

99: Other error

- **Another problem has occurred, identified with an error number other than 11 to 81.**
 - ▶ Turn the camera's power switch off and on.

Wireless LAN Notes

When using the transmitter with a wireless LAN, try the following corrective actions if the transmission rate drops, the connection is lost, or other problems occur.

Wireless LAN Terminal Installation and Antenna Position

- When using the transmitter indoors, install the wireless LAN terminal in the same room where you are shooting.
- Install the wireless LAN terminal higher than the transmitter.
- Install the device where people or objects do not come between it and the camera.
- Install the device as close as possible to the camera. In particular, note that during outdoor use in poor weather, rain may absorb radio waves and disrupt the connection.

Nearby Electronic Devices

If the transmission rate over a wireless LAN drops because of interference from the following electronic devices, switching to a wired LAN can resolve the problem.

- The transmitter communicates over wireless LANs via IEEE 802.11b/g and Bluetooth using radio waves in the 2.4 GHz band. For this reason, the wireless LAN transmission rate may drop if there are nearby microwave ovens, cordless telephones, microphones, or similar devices operating on the same frequency band.
- If a wireless LAN terminal on the same frequency band as the transmitter is used nearby, the transmission rate of the wireless LAN may drop.

Using Multiple Transmitters

- If multiple transmitters are connected to a single wireless LAN terminal, be careful not to use duplicate camera IP addresses.
- Note that the transmission rate drops when multiple transmitters access a single wireless LAN terminal.
- To reduce radio wave interference when there are multiple wireless IEEE 802.11b/g devices, leave a gap of four channels between each wireless LAN channel. For example, use channels 1, 6, and 11, channels 2, 7, and 12, or channels 3, 8, and 13. When IEEE 802.11a can be used, switch to IEEE 802.11a and specify a different channel.

Security

- Wireless LAN radio waves can be easily intercepted. For this reason, we recommend activating encrypted communication in the wireless LAN terminal settings.

Checking Network Settings

Windows

Click the Windows **[Start]** button → **[All Programs]** → **[Accessories]** → **[Command Prompt]**. Type **ipconfig/all** and press the **<Enter>** key.

The IP address assigned to the computer is displayed, as well as the subnet mask, gateway, and DNS server information.

To avoid using the same IP address for the computer and other devices on the network when configuring the IP address assigned to the camera (page 25), change the rightmost numbers here.

Macintosh

In Mac OS X, open the **[Terminal]** application, type **ifconfig -a**, and press the **<Return>** key. The IP address assigned to the computer is indicated in the **[en0]** item by **[inet]**, in the format *****.***.***.*****.

To avoid using the same IP address for the computer and other devices on the network when configuring the IP address assigned to the camera (page 25), change the rightmost numbers here.

* For information on the **[Terminal]** application, refer to the Mac OS X help.



10

Reference

Creating and Registering Captions

Follow these steps to create captions and register them on the camera, as introduced in "Adding a Caption Before Transfer" (p.35). When creating and registering captions, use a computer on which EOS Utility is installed.

Before you begin, attach the transmitter to the camera and use the USB cable provided with the camera to connect the camera to the computer. For instructions on connecting the camera to the computer with the USB cable and starting EOS Utility, refer to the Software Instruction Manual (PDF) provided with the camera. Note that captions cannot be created for cameras without an attached transmitter.



1 Start EOS Utility and select [Camera settings/Remote shooting].

- ▶ The camera settings/remote capture screen is displayed.



2 On the [Tf] tab, select [WFT Captions].

- ▶ The screen for caption creation is displayed.
- To acquire caption data stored on the camera, select [Load settings].

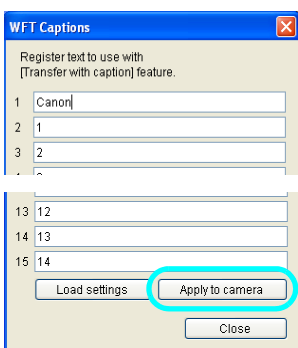

3 Enter the caption or captions.

- Enter up to 31 characters (in ASCII format).

4 Register the captions on the camera.

- Select [Apply to camera] to register your new captions on the camera.

Specifications

■ Type

Type: Image transfer accessory that can be used in wireless LANs and over Ethernet in wired LANs (IPsec-compatible). Can be connected via USB to external media, GPS devices, and Bluetooth units.

■ Wireless LAN

Standards compliance: IEEE 802.11a (WFT-E2 IIA/B/C) and ARIB STD-T71
IEEE 802.11b and ARIB STD-T66
IEEE 802.11g and ARIB STD-T66

Transmission method: OFDM modulation (IEEE 802.11a/g)
DS-SS modulation (IEEE 802.11b)

Transmission range: Approx. 150 m / 492 ft.
* With no obstructions between the transmitting and receiving antennas and no radio interference
* With a large, high-performance antenna attached to the wireless LAN access point

Transmission frequency: (central frequency) WFT-E2 IIA: 5,180 - 5,320 MHz, channels 36 - 64
5,745 - 5,825 MHz, channels 149 - 165
2,412 - 2,462 MHz, channels 1 - 11
WFT-E2 IIB: 5,180 - 5,320 MHz, channels 36 - 64
5,500 - 5,700 MHz, channels 100 - 140
2,412 - 2,472 MHz, channels 1 - 13
WFT-E2 IIC: 5,745 - 5,805 MHz, channels 149 - 161
2,412 - 2,472 MHz, channels 1 - 13
WFT-E2 IID: 2,412 - 2,462 MHz, channels 1 - 11

Connection method: Infrastructure or ad hoc mode
* Wi-Fi Protected Setup supported

Security: Authentication method: Open, shared key, WPA-PSK, and WPA2-PSK
Encryption: WEP, TKIP, and AES

■ Wired LAN

Standards compliance: IEEE 802.3u (Ethernet 10BASE-T and 100BASE-TX)

■ USB Connection

Connectable devices: External media, GPS devices, and Bluetooth units

■ Interfaces

Camera: Extension system terminal

Wired LAN: Ethernet RJ-45 port

External device: Hi-Speed USB port (for attaching external media, GPS devices, and Bluetooth units)

Image Capture Capacity

Approx. number of images

LAN	At Normal Temperature (23°C / 73°F)	At Low Temperature (0°C / 32°F)
Wireless LAN	1100	900
Wired LAN	1200	900

- * Using a fully charged LP-E4
- * Testing based on Camera & Imaging Products Association (CIPA) standards
- * Fewer images can be captured when transferring images over wireless LAN.
- * Fewer images can be captured when using bus-powered external media or GPS devices.

Dimensions and Weight

Dimensions (W x H x D): 26.0 x 97.7 x 31.8 mm / 1.0 x 3.8 x 1.3 in.

Weight: Approx. 80 g / 2.8 oz. (Body only)

Operating Environment

Temperature: 0°C - 45°C / 32°F - 113°F

Humidity: 85% or less

- All preceding specifications are based on Canon testing standards.
- Transmitter specifications and appearance are subject to change without notice

Model Number

WFT-E2 IIA : DS585802
 WFT-E2 IIB : DS585801
 WFT-E2 IIC : DS585803
 WFT-E2 IID : DS585804

DECLARATION OF CONFORMITY

We

Manufacturer	CANON INC.
	30-2, shimomaruko 3-chome, Ohta-ku, Tokyo 146-8501, Japan
Authorized representative in Europe	CANON EUROPA N.V
	Bovenkerkerweg 59-61 1185 XB Amstelveen The Netherlands

declare under our sole responsibility that the products

WLAN Module: Model CH9-1161

is in conformity with essential requirements of EC Directives

1999/5/EC

by applying the following standards

EC Directives	Reference of standards and amendments
1999/5/EC	EN300 328 V1.7.1
	EN301 893 V1.4.1
	EN301 489-1 V1.8.1
	EN301 489-17 V1.3.2
	EN60950-1: 2006
	EN62311: 2008

- Note:
1. The CE marking of Flash is affixed from the year '09.
 2. The quality system covering the production is implemented according to ISO 9000-series (EN 29000-series) or monitored based on appropriate measures.
 3. Copy of the rating plate of this model is attached.

Date: June 23, 2009



Kiyoshi Sahoyama
Manager
Image Communication Products Safety Promotion Dept.
CANON INC.

DECLARATION OF CONFORMITY

We

Manufacturer	CANON INC. 30-2, shimomaruko 3-chome, Ohta-ku, Tokyo 146-8501, Japan
Authorized representative in Europe	CANON EUROPA N.V Bovenkerkerweg 59-61 1185 XB Amstelveen The Netherlands

declare under our sole responsibility that the products

WLAN File Transmitter: Model DS585801 (Sales Name is WFT-E2 II B)

is in conformity with essential requirements of EC Directives

2004/108/EC

by applying the following standards

EC Directives	Reference of standards and amendments
2004/108/EC	EN55022: 2006 Class-B
	A1: 2007
	EN55024: 1998
	A1: 2001, A2: 2003

- Note:
1. The CE marking of this equipment is affixed from the year '09.
 2. The quality system covering the production is implemented according to ISO 9000-series (EN 29000-series) or monitored based on appropriate measures.
 3. Copy of the rating plate of this equipment is attached.
 4. LVD is not applicable since the rated voltage of this equipment is less than DC75V.
 5. This model contains WLAN Module Unit model CH9-1161. This unit is in conformity with the essential requirements of EC Directives 1995/5/EC. Please refer to the Declaration of Conformity for CH9-1161.

Date: September 17, 2009



Kiyoshi Sahoyama
Manager
Image Communication Products Safety Promotion Dept.
CANON INC.

DECLARATION OF CONFORMITY

We

Manufacturer	CANON INC. 30-2, shimomaruko 3-chome, Ohta-ku, Tokyo 146-8501, Japan
Authorized representative in Europe	CANON EUROPA N.V Bovenkerkerweg 59-61 1185 XB Amstelveen The Netherlands

declare under our sole responsibility that the products

WLAN File Transmitter: Model DS585804 (Sales Name is WFT-E2 II D)

is in conformity with essential requirements of EC Directives

2004/108/EC

by applying the following standards

EC Directives	Reference of standards and amendments
2004/108/EC	EN55022: 2006 Class-B
	A1: 2007
	EN55024: 1998
	A1: 2001, A2: 2003

- Note:
1. The CE marking of this equipment is affixed from the year '09 .
 2. The quality system covering the production is implemented according to ISO 9000-series (EN 29000-series) or monitored based on appropriate measures.
 3. Copy of the rating plate of this equipment is attached.
 4. LVD is not applicable since the rated voltage of this equipment is less than DC75V.
 5. This model contains WLAN Module Unit model CH9-1161. This unit is in conformity with the essential requirements of EC Directives 1995/5/EC. Please refer to the Declaration of Conformity for CH9-1161.

Date: September 17, 2009

Kiyoshi Sahoyama
 Manager
 Image Communication Products Safety Promotion Dept.
 CANON INC.



Statement on EC directive

Canon Inc. tímto prohlašuje, že tento CH9-1161 je ve shodě se základními požadavky a dalšími příslušnými ustanoveními směrnice 1999/5/ES.
Undertegnede Canon Inc. erklærer herved, at følgende udstyr CH9-1161 overholder de væsentlige krav og øvrige relevante krav i direktiv 1999/5/EF.
Hiermit erklärt <i>Canon Inc.</i> , dass sich das Gerät CH9-1161 in Übereinstimmung mit den grundlegenden Anforderungen und den übrigen einschlägigen Bestimmungen der Richtlinie 1999/5/EG befindet.
Käesolevaga kinnitab <i>Canon Inc.</i> seadme CH9-1161 vastavust direktiivi 1999/5/EÜ põhinõuetele ja nimetatud direktiivist tulenevatele teistele asjakohastele sätetele.
Hereby, Canon Inc., declares that this CH9-1161 is in compliance with the essential requirements and other relevant provisions of Directive 1999/5/EC.
Por medio de la presente Canon Inc. declara que el CH9-1161 cumple con los requisitos esenciales y cualesquiera otras disposiciones aplicables o exigibles de la Directiva 1999/5/CE.
ΜΕ ΤΗΝ ΠΑΡΟΥΣΑ Canon Inc. ΔΗΛΩΝΕΙ ΟΤΙ CH9-1161 ΣΥΜΜΟΡΦΩΝΕΤΑΙ ΠΡΟΣ ΤΙΣ ΟΥΣΙΩΔΕΙΣ ΑΠΑΙΤΗΣΕΙΣ ΚΑΙ ΤΙΣ ΛΟΙΠΕΣ ΣΧΕΤΙΚΕΣ ΔΙΑΤΑΞΕΙΣ ΤΗΣ ΟΔΗΓΙΑΣ 1999/5/EK.
Par la présente Canon Inc. déclare que l'appareil CH9-1161 est conforme aux exigences essentielles et aux autres dispositions pertinentes de la directive 1999/5/CE.
Con la presente <i>Canon Inc.</i> dichiara che questo CH9-1161 è conforme ai requisiti essenziali ed alle altre disposizioni pertinenti stabilite dalla direttiva 1999/5/CE.
Ar šo Canon Inc. deklarē, ka CH9-1161 atbilst Direktīvas 1999/5/EK būtiskajām prasībām un citiem ar to saistītajiem noteikumiem.
Šiuo Canon Inc. deklaruoja, kad šis CH9-1161 atitinka esminius reikalavimus ir kitas 1999/5/EB Direktyvos nuostatas.
Hierbij verklaart Canon Inc. dat het toestel CH9-1161 in overeenstemming is met de essentiële eisen en de andere relevante bepalingen van richtlijn 1999/5/EG.
Hawnhekk, <i>Canon Inc.</i> , jiddikjara li dan CH9-1161 jikkonforma mal-ftiġġiet essenzjali u ma provvedimenti oħrajn relevanti li hemm fid-Direttiva 1999/5/EC.
Alulírott, <i>Canon Inc.</i> nyilatkozom, hogy a <i>CH9-1161</i> megfelel a vonatkozó alapvető követelményeknek és az 1999/5/EC irányelv egyéb előírásainak.
Niniejszym Canon Inc. oświadczam, że CH9-1161 jest zgodny z zasadniczymi wymogami oraz pozostałymi stosownymi postanowieniami Dyrektywy 1999/5/EC.
Canon Inc. declara que este CH9-1161 está conforme com os requisitos essenciais e outras disposições da Directiva 1999/5/CE.
Canon Inc. izjavlja, da je ta CH9-1161 v skladu z bistvenimi zahtevami in ostalimi relevantnimi določili direktive 1999/5/ES.
Canon Inc. tímto vyhlasuje, že <i>CH9-1161</i> splňa základné požiadavky a všetky prislušné ustanovenia Smernice 1999/5/ES.
<i>Canon Inc.</i> vakuuttaa täten että <i>CH9-1161</i> tyyppinen laite on direktiivin 1999/5/EY oleellisten vaatimusten ja sitä koskevien direktiivin muiden ehtojen mukainen.
Härmed intygat <i>Canon Inc.</i> att denna CH9-1161 står i överensstämmelse med de väsentliga egenskapskrav och övriga relevanta bestämmelser som framgår av direktiv 1999/5/EG.
Hér með lýsir Canon Inc. yfir því að CH9-1161 er í samræmi við grunnkröfur og aðrar kröfur, sem gerðar eru í tilskipun 1999/5/EC.
Canon Inc. erklærer herved at udstyret CH9-1161 er i samsvar med de grunnleggende krav og øvrige relevante krav i direktiv 1999/5/EF.
С настоящия документ Canon Inc. декларира, че CH9-1161 е в съгласие с основните изисквания и съответните постановления на Директива 1999/5/EC.
Prin prezenta, Canon Inc. declară că acest CH9-1161 este conform cu cerințele principale și cu celelalte prevederi relevante ale Directivei 1999/5/EC.

FCC / IC Notice

Model DS585802/DS585804 (including WLAN Module Model CH9-1161)

This device complies with Part 15 of FCC Rules and RSS-Gen of IC Rules. Operation is subject to the following two conditions: (1) this device may not cause interference, and (2) this device must accept any interference, including interference that may cause undesired operation of this device.

Note: This equipment has been tested and found to comply with the limits for a Class B digital device, pursuant to part 15 of the FCC Rules. These limits are designed to provide reasonable protection against harmful interference in a residential installation.

This equipment generates, uses and can radiate radio frequency energy and, if not installed and used in accordance with the instructions, may cause harmful interference to radio communications. However, there is no guarantee that interference will not occur in a particular installation. If this equipment does cause harmful interference to radio or television reception, which can be determined by turning the equipment off and on, the user is encouraged to try to correct the interference by one or more of the following measures:

- Reorient or relocate the receiving antenna
- Increase the separation between the equipment and receiver.
- Connect the equipment into an outlet on a circuit different from that to which the receiver is connected.
- Consult the dealer or an experienced radio/TV technician for help.

The cable with the ferrite core provided with the digital camera must be used with this equipment in order to comply with Class B limits in Subpart B of Part 15 of the FCC rules.

Do not make any changes or modifications to the equipment unless otherwise specified in the manual. If such changes or modifications should be made, you could be required to stop operation of the equipment.

This transmitter must not be co-located or operated in conjunction with any other antenna or transmitter.

The available scientific evidence does not show that any health problems are associated with using low power wireless devices. There is no proof, however, that these low power wireless devices are absolutely safe. Low power Wireless devices emit low levels of radio frequency energy (RF) in the microwave range while being used. Whereas high levels of RF can produce health effects (by heating tissue), exposure to low-level RF that does not produce heating effects causes no known adverse health effects. Many studies of low-level RF exposures have not found any biological effects. Some studies have suggested that some biological effects might occur, but such findings have not been confirmed by additional research. DS585802/DS585804 has been tested and found to comply with FCC/IC radiation exposure limits set forth for an uncontrolled equipment and meets the FCC radio frequency (RF) Exposure Guidelines in Supplement C to OET65 and RSS-102 of the IC radio frequency (RF) Exposure rules.

For body worn operation, this model has been tested and meets the FCC RF exposure guidelines when used with the CANON INC. Cameras supplied or designated for this product. Use of other Cameras may not ensure compliance with FCC RF exposure guidelines.

Canon U.S.A Inc.
One Canon Plaza, Lake Success, NY 11042, U.S.A.
Tel No. (516)328-5600

This class B digital apparatus complies with Canadian ICES-003.

Index

Wireless and Wired LAN Functions

A

Account	50
Ad hoc	8, 21
Area of use	8
Authentication	21, 68
Auto power off	17

B

Batch transfer	36, 38, 39
Browser	52

C

Camera control	55
Caption	35
Channel	8
Connection	17

D

DHCP server	25
DNS address	25
DNS server	30

E

Encryption	21, 68
Encryption key	22
EOS Utility	13, 43, 47
EOSUtility	18
Error	92
ESS-ID	21

F

File of same name	68
Folder	31, 41
FTP server	13, 29
FTP trans.	18

G

Gateway	25
---------------	----

I

IEEE 802.11a	8
IEEE 802.11b/g	8
Image transfer	13, 29

Infrastructure	8, 21
IP address	25, 30
IPsec	68

J

JPEG	33
------------	----

K

Key format	22
Keyboard	27

L

LAN cable	20
Linked shooting	61
LinkedShot	19
Login	31
Logon name	50

M

MAC address	44
Master camera	63
Movie	32, 54, 55

N

Network	15
---------------	----

O

Open system	21
-------------------	----

P

Pairing	26, 44
Passive mode	68
Password	50
PBC mode	23
PIN code connection mode	24
PIN mode	24
Port number	30
Protect settings	68
Proxy	30
Pushbutton connection mode	23

R

RAW	33
RAW+JPEG	33
Remote capture	13, 43, 49, 55, 58, 59
Router	25

S

Select folder	31
Settings information.....	65
Shared key	21
Simple control.....	58
Slave camera	62
SSID	21
Stealth functions.....	23, 24
Storage.....	41
Subnet mask	25

T

Target	31
Target folder	68
TKIP	21
Transfer after shooting	36
Transfer history	40
Transfer with SET.....	34
Transferred images	41
Transferring images, automatic.....	32
Transferring images, individual images.....	34
Troubleshooting.....	91

U

URL	52
-----------	----

V

Viewing images	53
----------------------	----

W

Web	52
WEP	21
WFT Server	13, 49
WFTserver.....	19
Wi-Fi Protected Setup	23
Wired LAN	20
Wireless LAN specification.....	8
Wizard	17
WPA2-PSK.....	21
WPA-PSK.....	21
WPS (Wi-Fi Protected Setup).....	23, 24

Functions When Connected via USB

B

Backing up images	78
-------------------------	----

Backup	71, 80
Bluetooth.....	87
Bus-powered.....	71

C

Copying images	77
----------------------	----

E

Error	92
External media	13, 71, 75

G

GPS	83
GPS data	85
GPS device	13

H

Hard disk.....	71
----------------	----

M

Media	71
-------------	----

P

Power.....	74
Power management.....	74, 86

Q

Quick backup	79
--------------------	----

R

Replace existing image.....	78
-----------------------------	----

S

Self-powered.....	71
Skip image and continue.....	78

T

Troubleshooting	91
-----------------------	----

U

USB connection	71
----------------------	----



CANON INC. 30-2, Shimomaruko 3-chome, Ohta-ku, Tokyo 146-8501, Japan

U.S.A. ————— CANON U.S.A. INC.

One Canon Plaza, Lake Success, NY 11042-1198, U.S.A.
For all inquires concerning this product, call toll free in the U.S.
1-800-OK-CANON

CANADA ————— CANON CANADA INC. HEADQUARTERS

6390 Dixie Road, Mississauga, Ontario L5T 1P7, Canada

CANON CANADA INC. MONTREAL BRANCH

5990, Côte-de-Liesse, Montréal Québec H4T 1V7, Canada

CANON CANADA INC. CALGARY OFFICE

2828, 16th Street, N.E. Calgary, Alberta T2E 7K7, Canada

For all inquiries concerning this product, call toll free in Canada
1-800-OK-CANON

EUROPE, ————— CANON EUROPA N.V.

AFRICA & Bovenkerkerweg 59-61, 1185 XB Amstelveen, The Netherlands

MIDDLE EAST CANON FRANCE S.A.S.

17,Quai du Président Paul Doumer, 92414 Courbevoie Cedex, France

CANON UK LTD.

Woodhatch Reigate, Surrey RH2 8BF, United Kingdom

CANON DEUTSCHLAND GmbH

Europark Fichtenhain A10, 47807 Krefeld, Germany

CANON ITALIA S.p.A.

Via Milano 8, 20097 San Donato Milanese, (MI), Italy

CANON Schweiz A.G.

Industriestrasse 12, 8305 Dietlikon, Switzerland

Canon GmbH

Zetschegasse 11, A-1230 Vienna, Austria

CANON España,S.A.

Av. De Europa,6 Alcobendas 28108 Madrid, Spain

CANON Portugal S.A.

Rua Alfredo da Silva,14 Alfragide 2610-016 Amadora, Portugal

CENTRAL & ————— CANON LATIN AMERICA, INC.

SOUTH AMERICA 703 Waterford Way, Suite 400 Miami, FL 33126, U.S.A.

ASIA ————— CANON (China) Co., LTD

15F Jinbao Building No.89 Jinbao Street, Dongcheng District, Beijing 100005, China

CANON HONGKONG CO., LTD.

19/F., The Metropolis Tower, 10 Metropolis Drive, Hunghom, Kowloon, Hong Kong

CANON SINGAPORE PTE. LTD.

1 HarbourFront Avenue, #04-01 Keppel Bay Tower, Singapore 098632

CANON KOREA CONSUMER IMAGING INC.

Gangnam Finance Center 17F, 737, Yeoksam-Dong, Gangnam-Gu, Seoul, 135-984, Korea

OCEANIA ————— CANON AUSTRALIA PTY. LTD.

1 Thomas Holt Drive, North Ryde, Sydney N.S.W. 2113, Australia

CANON NEW ZEALAND LTD.

Akoranga Business Park, Akoranga Drive, Northcote, Auckland, New Zealand

JAPAN ————— CANON MARKETING JAPAN INC.

16-6, Kohnan 2-chome, Minato-ku, Tokyo 108-8011, Japan

This instruction manual is current as of November 2009. For information on using the transmitter with accessories introduced after this date, contact your nearest Canon Service Center.